

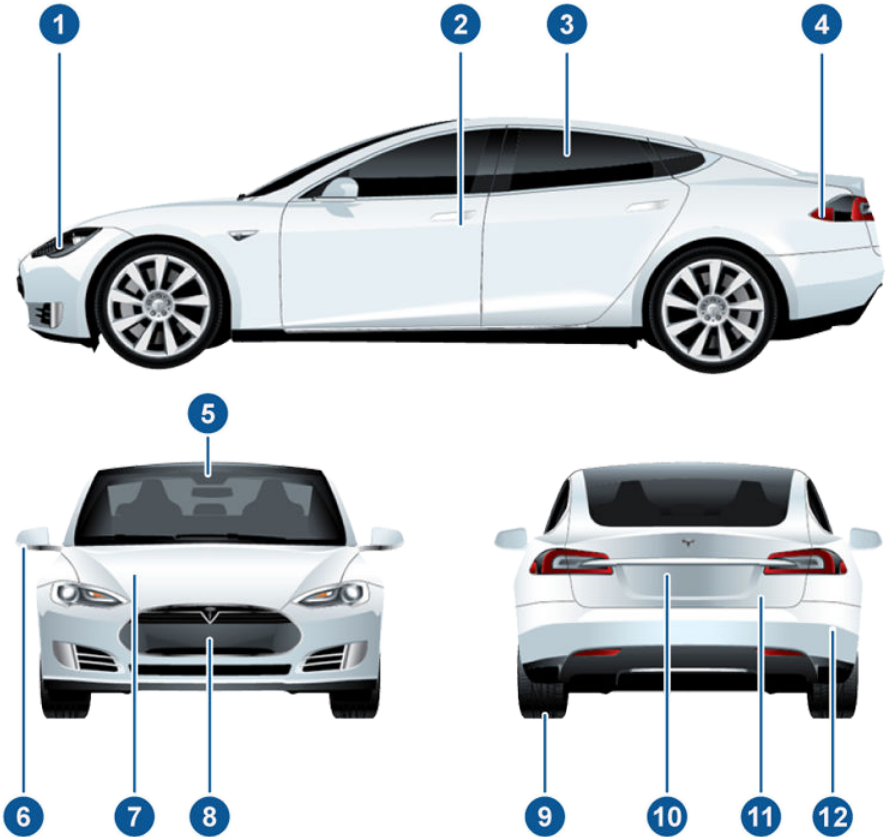

Overview.....	2	Wiper Blades and Washer Jets.....	147
Interior Overview.....	2	Fluid Reservoirs.....	149
Exterior Overview.....	3	Fuses.....	152
Opening and Closing.....	4	Jacking and Lifting.....	158
Doors.....	4	Parts and Accessories.....	159
Windows.....	9	Specifications.....	160
Rear Trunk.....	10	Identification Labels.....	160
Front Trunk.....	12	Vehicle Loading.....	161
Glove Box.....	14	Dimensions and Weights.....	163
Sunroof.....	15	Subsystems.....	166
Cup Holders.....	16	Wheels and Tires.....	169
Seating and Safety Restraints.....	17	Roadside Assistance.....	174
Front and Rear Seats.....	17	Contacting Roadside Assistance.....	174
Seat Belts.....	19	Instructions for Transporters.....	175
Child Safety Seats.....	22	Consumer Information.....	178
Tesla Built-In Rear Facing Child Seats.....	27	About this Owner Information.....	178
Airbags.....	31	Disclaimers.....	180
Driving.....	35	Reporting Safety Defects.....	181
Driver Profiles.....	35	Declarations of Conformity.....	182
Steering Wheel.....	37		
Mirrors.....	40		
Starting and Powering Off.....	41		
Gears.....	42		
Instrument Panel.....	43		
Lights.....	48		
Wipers and Washers.....	53		
Brakes.....	54		
Traction Control.....	56		
Park Assist.....	57		
Vehicle Hold.....	59		
Launch Mode.....	60		
Trip Information.....	61		
Getting Maximum Range.....	62		
Rear View Camera.....	64		
Driver Assistance.....	65		
About Driver Assistance.....	65		
Traffic-Aware Cruise Control.....	68		
Autosteer.....	74		
Auto Lane Change.....	77		
Autopark.....	79		
Lane Assist.....	83		
Collision Avoidance Assist.....	85		
Speed Assist.....	88		
Using the Touchscreen.....	90		
Touchscreen Overview.....	90		
Controls.....	94		
Settings.....	99		
Climate Controls.....	104		
Smart Air Suspension.....	108		
Media and Audio.....	110		
Phone.....	114		
Maps and Navigation.....	116		
Calendar.....	119		
Security Settings.....	121		
HomeLink [®] Universal Transceiver.....	122		
Connecting to Wi-Fi.....	124		
Software Updates.....	125		
Mobile App.....	126		
Charging.....	127		
Electric Vehicle Components.....	127		
Battery Information.....	129		
Charging Instructions.....	130		
Maintenance.....	134		
Maintenance Schedule.....	134		
Tire Care and Maintenance.....	135		
Temporary Tire Repair.....	140		
Cleaning.....	144		



1. Interior door handles ([Opening Doors from the Interior](#) on page 6)
2. Traffic-Aware Cruise Control ([Traffic-Aware Cruise Control](#) on page 68) and Autosteer (see [Autosteer](#) on page 74)
3. High beams ([High Beam Headlights](#) on page 51), Turn signals ([Turn Signals](#) on page 51), Wipers and washers ([Wiper Blades and Washer Jets](#) on page 147)
4. Steering wheel buttons - left ([Using Left Steering Wheel Buttons](#) on page 37)
5. Instrument panel ([Instrument Panel](#) on page 43)
6. Steering wheel buttons - right ([Using Right Steering Wheel Buttons](#) on page 38)
7. Gear selector ([Shifting Gears](#) on page 42)
8. Touchscreen ([Touchscreen Overview](#) on page 90)
9. Glove box button ([Glove Box](#) on page 14)
10. Power window switches ([Opening and Closing](#) on page 9)
11. Exterior mirror adjustment switches ([Mirrors](#) on page 40)
12. Seats ([Front and Rear Seats](#) on page 17)
13. Steering column adjuster (hidden from view in the above image) ([Steering Wheel](#) on page 37)
14. Horn ([Horn](#) on page 39)
15. Brakes ([Brakes](#) on page 54)
16. Hazard warning lights ([Hazard Warning Flashers](#) on page 52)
17. Cabin climate control ([Climate Controls](#) on page 104)
18. Cup holders ([Cup Holders](#) on page 16)



1. Exterior lights ([Lights](#) on page 48)
2. Door handles ([Using Exterior Door Handles](#) on page 6)
3. Sunroof (optional) ([Sunroof](#) on page 15)
4. Charge port ([Charging Instructions](#) on page 130)
5. Autopilot-equipped vehicles only: Forward looking camera ([About Driver Assistance](#) on page 65)
6. Exterior mirrors ([Mirrors](#) on page 40)
7. Autopilot-equipped vehicles only: Radar sensor (hidden from view in the above image) ([About Driver Assistance](#) on page 65)
8. Hood/Front trunk ([Front Trunk](#) on page 12)
9. Wheels and tires ([Wheels and Tires](#) on page 169)
10. Rear view camera ([Rear View Camera](#) on page 64)
11. Rear trunk/liftgate ([Rear Trunk](#) on page 10)
12. Ultrasonic sensors ([Park Assist](#) on page 57 and [About Driver Assistance](#) on page 65)



Keyless Locking and Unlocking

Locking and unlocking Model S is convenient. Although you must be carrying a valid key, there is no need to use it. Model S has sensors that can recognize the presence of a key within a range of approximately three feet (one meter). So you can keep your key in your pocket or purse and Model S detects it.

When you walk up to Model S carrying your key, doors automatically unlock. If a door handle is retracted, press it and it extends. If the Auto-Present Handles setting is turned on (see [Using Exterior Door Handles](#) on page 6), you do not need to touch the door handle. Instead, door handles extend automatically as you approach Model S. To open the rear trunk, press the switch located under the trunk's exterior handle.

Note: You can choose whether you want all doors, or just the driver's door, to unlock when you approach Model S carrying your key (see [Door Unlock Mode](#) on page 7).

When carrying your key with you, you can also open the rear trunk without having to use the key. Simply press the switch located under the trunk's exterior handle. Door Unlock Mode (see [Door Unlock Mode](#) on page 7) must be set to All.

Model S also locks automatically. If you set Walk-Away Door Lock to ON, Model S locks when you walk away carrying your key with you (see [Walk-away Locking](#) on page 7).

While sitting inside Model S, you can also lock and unlock the vehicle by touching the icon on the touchscreen's status bar or using the Controls screen.

Note: Depending on date of manufacture and options selected at time of purchase, some Model S vehicles are not equipped with the automatic locking and unlocking feature.

Using the Key

To quickly familiarize yourself with the key, think of the key as a miniature version of Model S, with the Tesla badge representing the front. The key has three buttons that feel like softer areas on the surface.

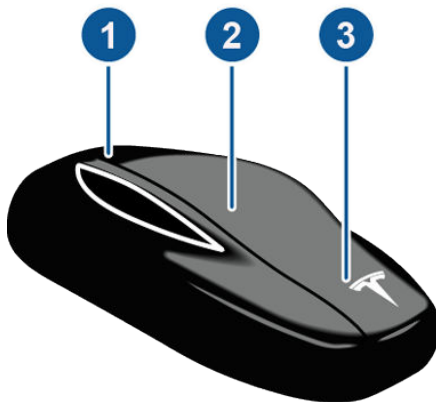

1. Trunk

- Double-click to open the rear trunk.
- If equipped with a powered liftgate, double-click to close the rear trunk. You can also single-click to stop the liftgate when it is moving.
- Hold the button down for one to two seconds to open the charge port door.

2. Lock/Unlock All

- Double-click to unlock Model S. Hazard warning lights flash twice and door handles extend.

Note: If the Door Unlock Mode is set to Driver, double-clicking unlocks only the driver's door and you will need to double-click again to unlock all doors and trunks. If set to All, the first double-click unlocks all doors and trunks. Use the touchscreen to change this setting (touch Controls > Settings > Vehicle > Door Unlock Mode).

- Single-click to lock doors and trunks (all doors and trunks must be closed). Hazard warning lights flash once and door handles retract.

3. Front trunk (also called the "frunk")



- Double-click to open the front trunk.

You do not need to point the key at Model S, but you must be within operating range (which varies depending on the strength of the key's battery).



If Model S is unable to detect the key, the touchscreen displays a message indicating that a key is not inside. Place the key where Model S can best detect it, which is below the 12V power socket (see [Key Not Inside](#) on page 41).

Radio equipment on a similar frequency can affect the key. If this happens, move the key at least one foot (30 cm) away from other electronic devices (phone, laptop, etc). If the key does not work, you may need to change its battery. If the key's battery is discharged, you can open Model S by following the unlocking procedure (see [Unlocking When the Key Doesn't Work](#) on page 7).

-  **Caution:** Remember to bring the key with you when you drive. Although you can drive Model S away from its key, you will be unable to power it back on after it powers off.
-  **Caution:** Protect the key from impact, high temperatures, and damage from liquids. Avoid contact with solvents, waxes and abrasive cleaners.

Replacing the Key Battery

The key's battery lasts for approximately a year. When the battery is low, a message displays on the instrument panel. Follow these steps to replace it:

1. With the key placed button side down on a soft surface, use a small flat-bladed tool to release the bottom cover.

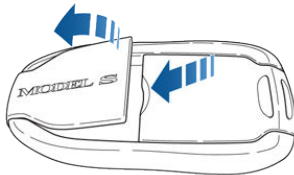

2. Remove the battery by lifting it away from the front retaining clips.

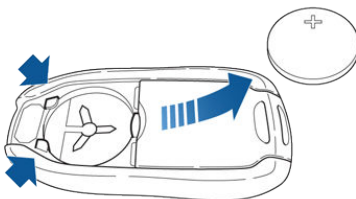

3. Insert the new battery (type CR2032) with the '+' side facing up.

Note: Wipe the battery clean before fitting and avoid touching the battery's flat surfaces. Finger marks on the flat surfaces of the battery can reduce battery life.

4. Holding the cover at an angle, align the tabs on the widest side of the cover with the corresponding slots on the key, then press the cover firmly onto the key until it snaps into place.

Getting More Keys

If you lose a key or require an additional one, contact Tesla. Model S can recognize up to five keys.

When ordering a new key for Model S, take all available keys with you for reprogramming.



Using Exterior Door Handles

A light press on a door handle extends it, provided Model S detects a valid key nearby.

You can set the door handles to extend automatically whenever you approach the driver's side carrying the key. On the touchscreen, touch Controls > Settings > Vehicle > Auto-Present Handles > On.

Note: Depending on date of manufacture and options selected at time of purchase, some Model S vehicles are not equipped with Auto-Present Handles.

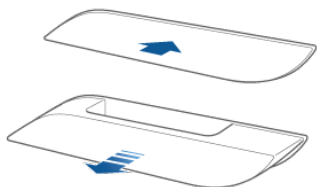

Insert your hand into the handle and pull to open the door.

Door handles retract if you do not use them within one minute after they extend. Just press a handle to extend it again. Door handles also retract a minute after the last door closes, when Model S begins moving, and when you lock Model S.

Note: To preserve battery life, Model S is designed to temporarily disable the Auto-Present Handles feature when:

- The key has been out of range for more than 48 hours.
- The key remains within range for five minutes after all doors have been closed.

In these cases, extend the handles by touching the driver's door handle or pressing the unlock button on the key. There is no need to reset the setting. The next time you approach Model S, provided the above conditions do not apply, handles automatically extend.



Whenever a door is open, the Door Open indicator displays on the instrument panel. The image of the Model S on the touchscreen Controls window also shows which door or trunk is open.

Opening Doors from the Interior

To open a door, pull the interior door handle toward you.

Note: If Model S is locked, the first pull unlocks the associated door, and the second pull opens it.



Note: To prevent children from opening rear doors using the interior handles, use the touchscreen, Controls > Settings > Vehicle > Child Protection Lock, to turn on the child-protection locks (see [Child-protection Lock](#) on page 7).

Interior Locking and Unlocking

From inside Model S, you can use the touchscreen to lock or unlock doors and trunks, provided a valid key is inside the vehicle. Touch the lock icon on the touchscreen's status bar.

When you stop Model S and engage the Park gear, you can choose whether you want doors to unlock or remain locked. To do so, touch Controls > Settings > Vehicle > Unlock On Park. When set to ON, doors automatically unlock when you engage the Park gear.

You can also unlock doors and present handles by pressing the Park button on the end of the gear selector a second time (i.e. after pressing it once to engage the Park gear).

Note: If a door or trunk is still open when you lock Model S, it locks when you close it.



Door Unlock Mode

You can choose whether you want all doors, or just the driver's door, to unlock when you approach your vehicle carrying your key. To do so, touch Controls > Settings > Vehicle > Door Unlock Mode and choose Driver or All.

Child-protection Lock

Model S has child-protection locks on the rear doors and liftgate to prevent them from being opened using interior handles. Use the touchscreen to turn child protection locks on or off. Touch Controls > Settings > Vehicle > Child Protection Lock.

Note: It is recommended that you turn child-protection locks on whenever children are seated in the rear seats.

Drive-away Locking

Model S automatically locks all doors (including the trunks) whenever your driving speed exceeds 5 mph (8 km/h).

Walk-away Locking

Doors and trunks can automatically lock whenever you walk away carrying the key.

To turn this feature on or off, touch Controls > Settings > Vehicle > Walk-Away Door Lock.

Note: Depending on date of manufacture and options selected at time of purchase, some Model S vehicles are not equipped with the Walk-Away Door Lock feature.

Note: If all doors are closed and you use the key to unlock Model S, walk-away locking is temporarily suspended until the next time Model S powers on (such as when you press the Brake pedal to engage a driving gear), or until you use the key again to lock Model S. This allows you to keep Model S unlocked in your garage.

Unlocking When the Key Doesn't Work

If Model S does not unlock when you walk up to it, or when you press the unlock button on your key, the key's battery may be dead. If this is the case, you can still unlock and drive Model S.

To unlock Model S (and disable the security alarm), first position the key near the base of the passenger side windshield wiper, as shown. Then press the front passenger door handle. If Model S doesn't unlock, try adjusting the position of the key. The key must be in the correct position.

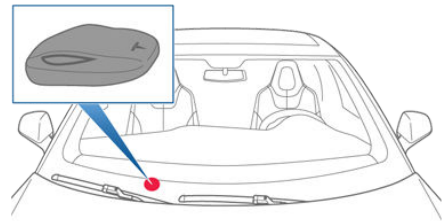

To drive Model S, place the key against the center console, immediately below the 12V power outlet, then press and hold the brake pedal to turn Model S on.

Note: Unlocking Model S using this method disables walk-away locking. You must manually re-enable walk-away locking after replacing the key's battery.

For instructions on how to replace the key's battery, see [Replacing the Key Battery](#) on page 5.



Opening Interior Doors with No Power

If Model S has no electrical power, front doors open as usual using the interior door handles. To open the rear doors, fold back the edge of the carpet below the rear seats to expose the mechanical release cable. Pull the mechanical release cable toward the center.

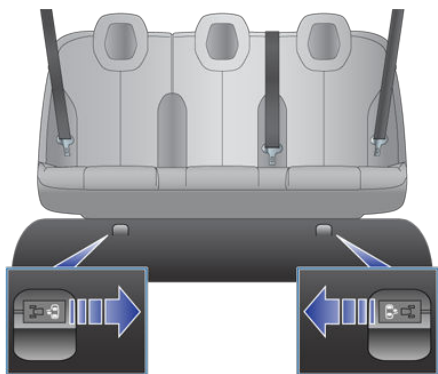



Opening and Closing

Press down on a switch to lower the associated window all the way down. Window switches operate at two levels. To lower a window partially, hold the switch and release when the window is at the desired position.

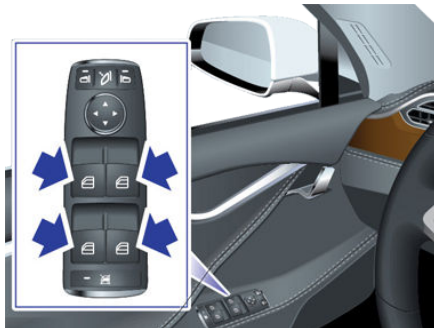

Similarly, pull a switch to raise the associated window. This also operates at two levels—when raising, hold the switch and release when the window is at the desired position.

- ⚠ Warning: Before closing a power window, it is the driver's responsibility to ensure that all occupants, especially children, do not have any body parts extended through the window's opening. Failure to do so can cause serious injury.
- ⚠ Warning: When leaving Model S, always take your key with you. Leaving the key in Model S allows all doors, windows, and controls to be fully operational and can cause hazardous, unauthorized or unintentional use of Model S.

Locking Rear Windows

To prevent passengers from using the rear window switches, press the rear window lock switch. The switch light turns on. To unlock rear windows, press the switch again.



- ⚠ Warning: To ensure safety, it is recommended that you lock the rear windows whenever children are seated in the rear seats.
- ⚠ Warning: Never leave children unattended in Model S.



Opening

To open the rear trunk, do one of the following:

- Touch Controls > Trunk on the touchscreen.
- Double-click the rear trunk button on the key.
- Press the switch located under the exterior handle (depending on date of manufacture and options selected at time of purchase, some Model S vehicles require you to first unlock Model S).



When the liftgate is open, the instrument panel displays the Door Open indicator light. The image of the Model S on the touchscreen Controls window also displays the open trunk.

To stop a powered liftgate while it is moving, single-click the Trunk button on the key. Then, when you double-click the Trunk button, it moves again, but in the opposite direction (provided it was not almost entirely open or closed when you stopped it). For example, if you single-click to stop the liftgate while it is opening, when you double-click, it closes.

To open the trunk from inside in the unlikely situation in which Model S has no electrical power, see [Opening with No Power](#) on page 11.

Closing

If Model S is not equipped with a powered liftgate, close the trunk by pulling down on the liftgate and pushing firmly until it is fully closed.

To close the powered liftgate, do one of the following:

- Double-click the trunk button on the key.
- Touch Controls > Trunk on the touchscreen.
- Press the switch located on the underside of the liftgate (see [Adjusting the Opening Height](#) on page 10).

If a powered liftgate senses an obstruction when closing, it automatically opens and sounds two chimes. Remove the obstruction and try closing it again. If it cannot close the second time, powered operation is temporarily disabled. Close it manually to restore powered operation.

Note: The power closing feature is also temporarily disabled if you leave the powered liftgate open for more than an hour.

Adjusting the Opening Height

If Model S is equipped with a powered liftgate, you can adjust its opening height to make it easier to reach:

1. Open the liftgate, then manually lower it to the desired opening height.



2. Press and hold the button on the underside of the liftgate for two seconds until you hear a confirmation beep.
3. Confirm that you have set it to the desired height by closing the liftgate, then reopening it.



Interior Release

To open the trunk from inside a Model S equipped with the Tesla Built-In Rear Facing Child Seats, press the interior release switch located inside the rear trunk and push the liftgate up. If Model S is locked and is equipped with a power liftgate, the first press unlocks the rear trunk and the second press opens it.

Note: If Model S is not equipped with the the Tesla Rear Facing Child Seats, the switch may appear to exist, but it will be inactive and pressing it does not release the liftgate.



If Model S is equipped with the power liftgate, you do not need to push it up. When you press the release switch, it opens, and when you pull the switch, it closes.

Note: The interior release switch is disabled if child-protection locks are turned on (see [Child-protection Lock](#) on page 7), or if Model S is moving.

Opening with No Power

If Model S has no electrical power, you can open the rear trunk from inside. Use the mechanical release cable located on the underside of the liftgate, next to the interior light.

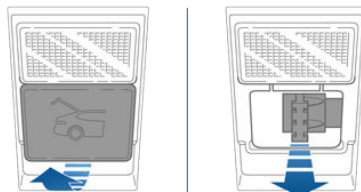

1. Remove the cover by pulling its lower edge very firmly toward you.
2. Pull the cable to release the latch.
3. Push the liftgate open.



Opening

To open the front trunk:

Touch ControlsFront Trunk on the touchscreen, or double-click the front trunk button on the key.

Pull the hood up.



The door open indicator displays on the instrument panel when the front trunk is open. The image of the Model S on the touchscreen Controls window also displays the open trunk.

The front trunk locks whenever Model S is locked using the touchscreen, externally using the key or walk-away locking, or when Valet mode is active (see [Valet Mode](#)).

To open the front trunk in the unlikely situation in which Model S has no electrical power, see [Opening with No Power](#).

Closing

The Model S body is made of lightweight aluminum. Therefore, the hood is not heavy enough to latch under its own weight and applying pressure on the front edge or center of the hood can cause damage. To close the hood:

- Lower the hood fully until it touches the latches.
- Place both hands on the front of the hood in the areas shown below (in green), then press down firmly to engage the latches.
- Lift the front edge of the hood to ensure it is fully closed.

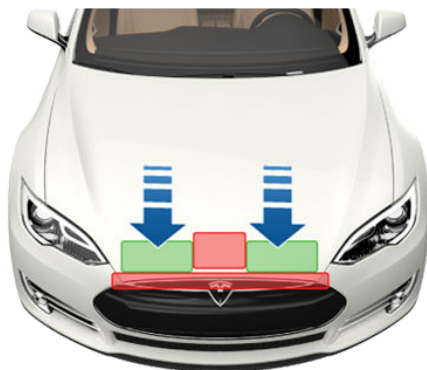

 **Caution:** To prevent damage:

- Apply pressure only to the green areas illustrated above. Applying pressure to the red areas can cause damage.
- Do not close the hood with one hand. Doing so applies concentrated force in one area and can result in a dent or crease.
- Do not apply pressure to the leading edge of the hood because this can crease the edge.
- Do not slam or drop the hood.

 **Warning:** Do not drive with the hood secured by the secondary catch alone.



Interior Emergency Release

An interior release button inside the front trunk allows a person locked inside to get out. This release button is active whenever Model S is stationary.

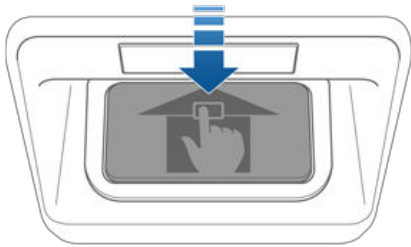

Press the interior release button to open the front trunk, then push up on the hood.

Note: The button glows for several hours after a brief exposure to ambient light.

Opening with No Power

If Model S has no electrical power, or if you are unable to open the front trunk using the touchscreen or key, pull the mechanical release lever located below the glove box. This releases the primary catch.



Note: The mechanical release lever is not available on all versions of Model S. For dual motor vehicles and some newer models, contact Tesla for assistance.

Then push down on the secondary catch lever and lift the hood. You may need to push the hood down slightly to release the pressure against the secondary catch.





Opening and Closing

To open the glove box, press the switch located on the side of the touchscreen. If you leave the glove box open for five minutes, its light automatically turns off.

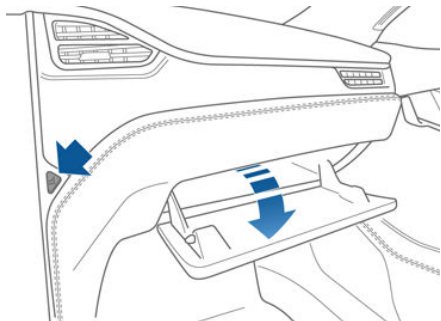

Note: The glove box locks whenever Model S is locked externally, using the key or walk-away locking. It also locks when Model S is in Valet mode (see [Valet Mode](#) on page 35). It does not lock when Model S is locked using the touchscreen.

⚠ Warning: When driving, keep the glove box closed to prevent injury to a passenger if a collision or sudden stop occurs.



Opening and Closing

If your Model S is equipped with a sunroof, touch Controls > Sunroof on the touchscreen to operate it. Drag, or tap on, the sunroof slider bar, or touch the image of the sunroof and drag it. The sunroof moves to the selected position.



Touch OPEN once to open the sunroof to its comfort position (75% open to minimize wind noise). Or, move the sunroof to the comfort position by dragging the slider bar to the indent position. If you find wind noise (which varies depending on driving speed) excessive, even with the sunroof in the comfort position, open a window slightly.

Touch OPEN twice to open the sunroof fully.

Touch CLOSE to fully close the sunroof.

If the sunroof's safety mechanism detects any obstruction, it does not close. If, after removing the obstruction, it still does not close, touch and hold CLOSE to override the sunroof's anti-trap mechanism.

Touch VENT to open the sunroof slightly.

To stop the sunroof from moving at any time, touch the image of the sunroof.

⚠ Caution: Remove snow and ice before opening the sunroof. Opening a sunroof covered in snow and ice can cause damage.

⚠ Warning: Do not allow occupants to extend any part of their body through the sunroof. Doing so can cause serious injury from flying debris, tree branches, or other obstructions.

⚠ Warning: Before closing the sunroof, ensure that occupants, especially children, do not have any body part extended through the sunroof opening. Failure to do so can cause serious injury.

⚠ Warning: Do not carry an object that protrudes through the sunroof. Doing so can damage the sunroof's seals and anti-trap mechanism, and can cause injury to occupants.



Opening and Closing

To expose a cup holder, slide back the armrest.

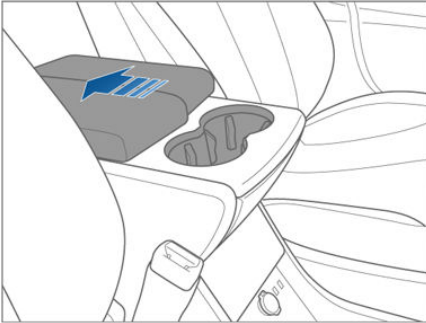



Correct Driving Position

The seat, head support, seat belt and airbags work together to maximize your safety. Using these correctly ensures greater protection.

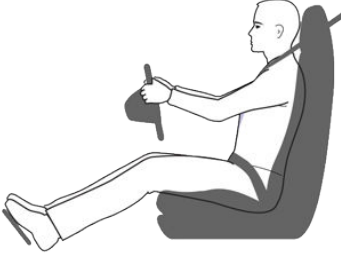

Position the seat so you can wear the seat belt correctly, while being as far away from the front airbag as possible:

1. Sit upright with both feet on the floor and the seat back reclined no more than 30 degrees.
2. Make sure you can easily reach the pedals and that your arms are slightly bent when holding the steering wheel. Your chest should be at least 10 inches (25 cm) from the center of the airbag cover.
3. Place the shoulder section of the seat belt mid-way between your neck and your shoulder. Fit the lap section of the belt tightly across your hips, not across your stomach.

Model S seats include integrated head supports that cannot be adjusted or removed.

Adjusting the Driver's Seat

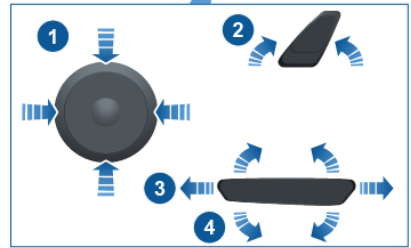
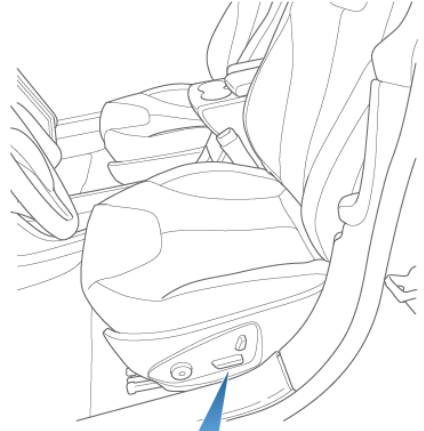

1. Adjust lumbar support.
2. Adjust backrest.
3. Move seat forward/backward.
4. Adjust the seat's height and tilt angle.

⚠ Warning: Do not adjust seats while driving. Doing so increases the risk of a collision.

⚠ Warning: Riding in a moving vehicle with the seat back reclined can result in serious injuries in a collision, as you could slide under the lap belt or be propelled into the seat belt. Ensure your seat back is reclined no more than 30 degrees when the vehicle is moving.



Folding Rear Seats

Model S has a split rear seat that can fold forward.

Note: If Model S is equipped with the optional executive rear seats, these seats do not fold forward.

Before folding, remove items from the seats and the rear foot well. To allow the rear seat backs to fold completely flat, you may need to move the front seats forward.

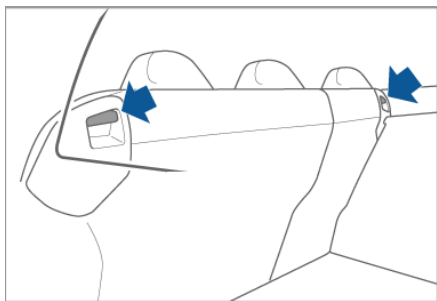

To fold a rear seat, press the corresponding lever and fold the seat forward.

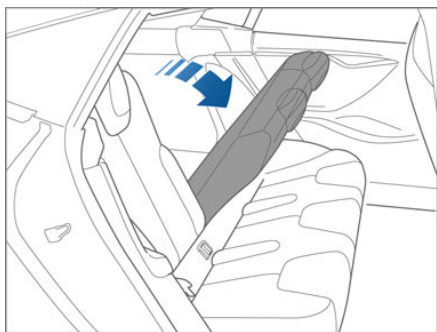

Raising Rear Seats

Before raising a rear seat, make sure that the seat belts are not trapped behind the backrest.

Pull the seat back upward until it locks into place.

To confirm that the seat back is locked in the upright position, try pulling it forward.

⚠ Warning: Always ensure the seat backs are locked in their upright position. Failure to do so increases the risk of injury.

Head Supports

Seats include integrated head supports that cannot be adjusted or removed.

Seat Heaters

The front seats are equipped with heating pads that operate at three levels from 3 (highest) to 1 (lowest). To operate the seat heaters, see [Climate Controls](#) on page 104.

If Model S is equipped with the optional cold weather package, you can also control seat heaters in all rear seating positions, as well as heated wipers and washer nozzles by touching [Controls > Cold Weather](#) (see [Controls](#) on page 94).

Seat Covers

Do not use seat covers on Model S. Doing so could restrict deployment of the side air bags if an accident occurs. It can also reduce the accuracy of the occupant detection system.



Wearing Seat Belts

Using seat belts and child safety seats is the most effective way to protect occupants if a collision occurs. Therefore, wearing a seat belt is required by law in most jurisdictions.

Both the driver and passenger seats are equipped with three-point inertia reel seat belts. Inertia reel belts are automatically tensioned to allow occupants to move comfortably during normal driving conditions. To securely hold child safety seats, all passenger seating positions are equipped with an automatic locking retractor (ALR) that, by pulling the seat belt beyond the length needed for a typical adult occupant, locks the belt into place until the seat belt is unbuckled (see [Installing Seat Belt Retained Child Seats](#) on page 24).

The seat belt reel automatically locks to prevent movement of occupants if Model S experiences a force associated with hard acceleration, braking, cornering, or an impact in a collision.



The seat belt reminder on the instrument panel alerts you if a seat belt for an occupied seat is not fastened. If the belt remains unfastened, the reminder flashes and an intermittent chime sounds. If all occupants are buckled up and the reminder stays on, re-fasten seat belts to ensure they are correctly latched. Also remove any heavy objects (such as a briefcase) from an unoccupied seat. If the reminder light continues to stay on, contact Tesla.

To Fasten a Belt

1. Ensure correct positioning of the seat.

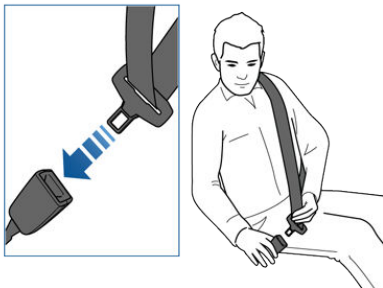

2. Draw the belt out smoothly, ensuring the belt lays flat across the pelvis, chest and mid-point of your collar bone, between the neck and shoulder.
3. Insert the latch plate into the buckle and press together until you hear a click indicating it is locked in place.
4. Pull the belt to check that it is securely fastened.
5. Pull the diagonal part of the belt toward the reel to remove excess slack.

To Release a Belt

Hold the belt near the buckle to prevent the belt from retracting too quickly, then press the button on the buckle. The belt retracts automatically. Ensure there is no obstruction that prevents the belt from fully retracting. The belt should not hang loose. If a seat belt does not fully retract, contact Tesla.

Wearing Seat Belts When Pregnant

Do not put the lap or shoulder sections of the seat belt over the abdominal area. Wear the lap section of the belt as low as possible across the hips, not the waist. Position the shoulder portion of the belt between the breasts and to the side of the abdomen. Consult your doctor for specific guidance.



- ⚠ Warning:** Never place anything between you and the seat belt to cushion the impact in the event of an accident.



Seat Belt Pre-tensioners

The front seat belts are equipped with pre-tensioners that work in conjunction with the airbags in a severe frontal collision. The pre-tensioners automatically retract both the seat belt anchor and the seat belt webbing, reducing slack in both the lap and diagonal portions of the belts, resulting in reduced forward movement of the occupant.

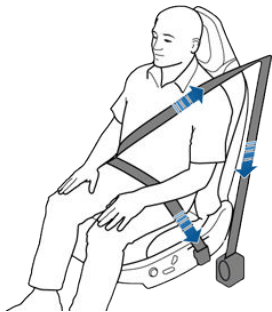

If the pre-tensioners and airbags did not activate in an impact, this does not mean they malfunctioned. It usually means that the strength or type of force needed to activate them was not present.

Warning: Once the seat belt pre-tensioners have been activated, they must be replaced. After any accident, have the airbags, seat belt pre-tensioners and any associated components checked and, if necessary, replaced.

Testing Seat Belts

To confirm that seat belts are operating correctly, perform these three simple checks on each seat belt.





1. With the seat belt fastened, give the webbing nearest the buckle a quick pull. The buckle should remain securely locked.
2. With the belt unfastened, unreel the webbing to its limit. Check that unreeling is free from snags, and visually check the webbing for wear. Allow the webbing to retract, checking that retraction is smooth and complete.
3. With the webbing half unreeled, hold the tongue plate and pull forward quickly. The mechanism should lock automatically and prevent further unreeling.

If a seat belt fails any of these tests, contact Tesla immediately.

Seat Belt Warnings

- Warning:** Seat belts should be worn by all occupants at all times, even if driving for a very short distance. Failure to do so increases the risk of injury or death if an accident occurs.
- Warning:** Secure small children in a suitable child safety seat. Always follow the child safety seat manufacturer's instructions when installing.
- Warning:** Ensure that all seat belts are worn correctly. An improperly worn seat belt increases the risk of injury or death if an accident occurs.
- Warning:** Do not wear seat belts over hard, fragile or sharp items in clothing, such as pens, keys, eyeglasses, etc. The pressure from the seat belt on such items can cause injury.
- Warning:** Seat belts should not be worn with any part of the strap twisted.
- Warning:** Each seat belt assembly must be used by one occupant only. It is dangerous to put a seat belt around a child being carried on an occupant's lap.
- Warning:** Seat belts that have been worn in an accident must be inspected or replaced by Tesla, even if damage to the assembly is not obvious.
- Warning:** Seat belts that show signs of wear (such as fraying), or have been cut or damaged in any way, must be replaced by Tesla.



-  Warning: Avoid contaminating a seat belt's components with any chemicals, liquids, grit, dirt or cleaning products. If a seat belt fails to retract or latch into the buckle, it must be replaced immediately. Contact Tesla.
-  Warning: Do not make modifications or additions that can prevent a seat belt mechanism from taking up slack, or that can prevent a seat belt from being adjusted to remove slack. A slack belt greatly reduces occupant protection.
-  Warning: Do not make modifications that can interfere with the operation of a seat belt, or that can cause a seat belt to become inoperable.
-  Warning: When seat belts are not in use, they should be fully retracted and not hanging loose. If a seat belt does not fully retract, contact Tesla.



Guidelines for Seating Children

Your Model S seat belts in the front and second row seats are designed for adults and larger children. You must restrain infants and small children in the second row seats only, and you must use a suitable child safety seat appropriate for the child's age, weight, and size. Never use child safety seats in the front row passenger seat. Carefully follow the instructions provided by the manufacturer of the child safety seat.

If your Model S is equipped with the optional Tesla built-in rear facing child seats, these seats are child safety seats and are designed only for children within a specific height and weight range (see [Tesla Built-In Rear Facing Child Seats](#) on page 27).



Choosing a Child Safety Seat

All children age 12 and under should ride in the rear (second row) seats. Always use a child safety seat suitable for a young child's age and weight. The following table is based on child safety seat recommendations determined by National Highway Traffic Safety Administration (NHTSA). For more information, go to www.nhtsa.gov/ChildSafety/Guidance.

	Infants	Toddlers	Young children
Age	Birth to 1 year*	Over 1 year*	4 years and older, and less than 57 in. (145 cm) tall
Weight	Up to at least 20 lbs (9 kg)*	Over 20 lbs (9 kg) (minimum) and up to 40 lbs (18 kg)*	Over 40 lbs (18 kg)
Type of child safety seat	Rear facing (or convertible)	Forward facing (or convertible)*	Seat belt retained booster seat
Seat position	Rear facing only*	Forward facing*	Forward facing
Recommended attachment method	If combined weight of child and safety seat is up to 65 lbs (29 kg), attach using either LATCH** (lower anchor only) or the seat belt only.*** If combined weight of child and safety seat is over 65 lbs (29 kg), attach using the seat belt only.***	If combined weight of child and safety seat is up to 65 lbs (29 kg), attach using either LATCH** (both lower anchors and top tether anchor), or the seat belt and upper tether strap.*** If combined weight of child and safety seat is over 65 lbs (29 kg), attach using the seat belt and upper tether strap.***	Attach booster seats using the seat belt only.
<p>* Many child safety seats currently available allow children to ride rear-facing using the child safety seat's integrated 5-point harness for a longer period of time BASED UPON SPECIFIC HEIGHT AND WEIGHT LIMITS. Keep your child in a rear facing seat for as long as possible. CHECK THE CHILD SAFETY SEAT MANUFACTURER'S INSTRUCTIONS AND CAREFULLY FOLLOW ALL INSTRUCTIONS</p> <p>** LATCH - Lower Anchors and Tethers for Children. In Canada, this is also called Lower Universal Anchorage System (LUAS), or CANFIX.</p> <p>*** Subject to instructions provided by the child safety seat manufacturer.</p>			

⚠ Warning: Laws that govern how and where children should be carried when traveling in a vehicle are subject to change. It is the driver's responsibility to keep up to date on, and comply with, all current regulations in the region(s) where Model S is driven. To check the child passenger safety laws for your state, go to: http://www.ghsa.org/html/stateinfo/laws/childsafety_laws.html.



Seating Larger Children

If a child is too large to fit into a child safety seat, but too small to safely fit into the standard seat belts, use a booster seat appropriate for the child's age and size. Carefully follow the manufacturer's instructions to secure the booster seat using the seat belts. Do not use the LATCH system to secure booster seats, even in situations where the booster seat is equipped with the LATCH system.

Installing Child Safety Seats

There are two general methods used to install child safety seats:

- Seat belt retained - these seats are secured using the vehicle's seat belts (see [Installing Seat Belt Retained Child Seats](#) on page 24).
- LATCH retained - these seats can attach to anchor bars built into the vehicle's rear seats (see [Installing LATCH Child Seats](#) on page 25).

Check the child safety seat manufacturer's instructions and the table on [Child Safety Seats](#) on page 22 to determine which installation method to use. Some child safety seats can be installed using either method. Always follow the child safety seat manufacturer's instructions.

Installing Seat Belt Retained Child Seats

First, make sure that the child falls into the correct weight range for the seat.

Avoid dressing the child in bulky clothing and do not place any objects between the child and the restraint system.

Adjust harnesses for every child, every trip.

To securely hold child safety seats, all passenger seating positions are equipped with an automatic locking retractor (ALR) that, by pulling the seat belt beyond the length needed for a typical adult occupant, locks the belt into place until the seat belt is unbuckled and the webbing is fully retracted. The ALR mechanism operates as a ratchet, winding in slack and preventing the seat belt from extending any further until it has been completely rewound. When installing a child safety seat, engage the belt's automatic locking retractor by pulling the seat belt webbing until it is fully extended. The ALR system engages only when the seat belt is at its maximum extension point.

Note: An automatic locking retractor disengages only when the seat belt is unbuckled and fully retracted. The belt can then be worn as a normal belt, sliding freely in and out and locking tight only in an emergency. Once disengaged, the belt must be fully extended to re-engage the locking mechanism whenever you install a child safety seat.

Always follow the detailed instructions provided by the child safety seat manufacturer. General guidelines are provided below.

1. Place the child safety seat in Model S, and fully extend the seat belt. Route and buckle the seat belt in accordance with the child safety seat manufacturer's instructions.

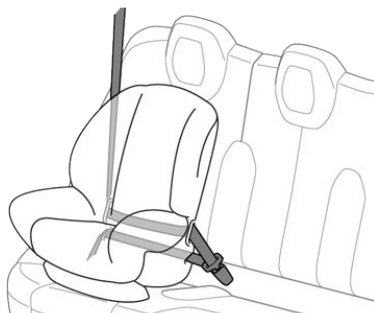

2. Allow the seat belt to retract, and remove all slack in the seat belt while firmly pushing the child safety seat into the Model S seat.
3. If the seat belt retained child safety seat has an upper tether, attach it to the back of the seat (see [Attaching Upper Tether Straps](#) on page 25).



Installing LATCH Child Seats

Lower LATCH anchors are provided in the second row outboard seats. The anchors are located between the seat's back rest and rear cushion. The exact location of each anchor is identified by a child safety seat identification button, illustrated below. The button is located on the seat back, directly above its associated anchor.

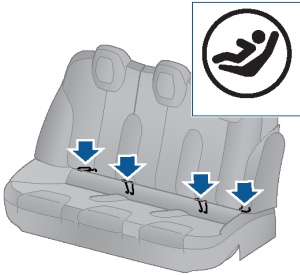

Install LATCH child safety seats in the outboard seating positions only. Use only a seat belt retained seat in the center position.

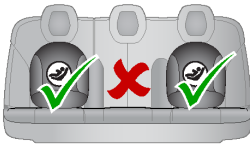

To install a LATCH child safety seat, slide the safety seat latches onto the anchor bars until they click into place. Carefully read and follow the instructions provided by the child safety seat manufacturer.

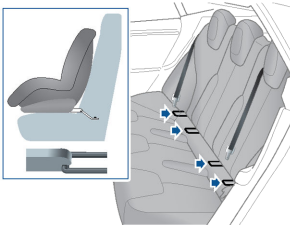

Once installed, test the security of the installation before seating a child. Attempt to twist the child safety seat from side to side and try to pull it away from the seat, then check that the anchors are still securely in place.

Attaching Upper Tether Straps

If an upper tether strap is provided, attach its hook to the anchor point located on the back of the rear seats.

Always position single-strap tethers to run over the top of the head support. For dual-strap tethers, position a strap on each side of the head support. Tighten according to the child safety seat manufacturer's instructions.

Note: To prevent the single-strap tether from moving side to side, the top of the head support deforms.

Note: If Model S is equipped with the optional six seat interior, a centre seating position is not available in the second row.

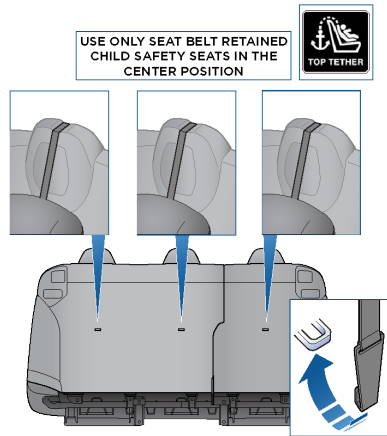

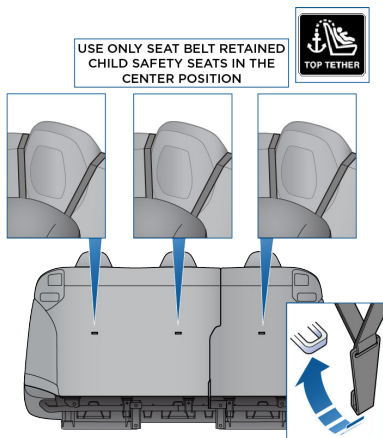

Testing a Child Safety Seat

Before seating a child, always make sure the child safety seat is not loose:

1. Hold the child safety seat by the belt path and try to slide the safety seat from side to side and front to back.
2. If the seat moves more than one inch (2.5 cm), it is too loose. Tighten the belt or reconnect the LATCH retained child safety seat.
3. If you are unable to reduce slack, try a different seat location or try another child safety seat.

Warnings - Child Safety Seats

- ⚠** Warning: Extreme hazard! Do not seat a child on the front passenger seat even if you are using a child safety seat. This seat has an airbag in front of it. Although this airbag is disabled when Model S detects a lightweight passenger, do not rely on technology to protect your child.
- ⚠** Warning: Child restraint systems are designed to be secured in vehicle seats by lap belts or the lap belt portion of a lap-shoulder belt. Children could be endangered in a crash if their child restraints are not properly secured in the vehicle
- ⚠** Warning: According to accident statistics, children are safer when properly restrained in the rear seating positions than in the front seating positions.

- ⚠** Warning: Do not use a forward facing child safety seat until your child weighs over 20 lbs (9 kg) and can sit independently. Up to the age of two, a child's spine and neck are not sufficiently developed to avoid injury in a frontal impact.
- ⚠** Warning: Do not allow a baby or infant to be held on a lap. All children should be restrained in an appropriate child safety seat at all times.
- ⚠** Warning: To ensure children are safely seated, follow all instructions provided in this document and by the manufacturer of the child safety seat.
- ⚠** Warning: Children should ride in a rear facing child safety seat using the seat's integrated 5-point harness for as long as possible.
- ⚠** Warning: Do not use seat belt extenders on a seat belt that is being used to install a child safety seat or booster seat.
- ⚠** Warning: When seating larger children, make sure the child's head is supported and the child's seat belt is properly adjusted and fastened. The shoulder portion of the belt must be away from the face and neck, and the lap portion must not be over the stomach.
- ⚠** Warning: Never attach two child safety seats to one anchor point. In a collision, one anchor point may be incapable of securing both seats.
- ⚠** Warning: Child restraint anchors are designed to withstand only those loads imposed by correctly fitted child restraints. Under no circumstances are they to be used for adult seatbelts, harnesses, or for attaching other items or equipment.
- ⚠** Warning: Always check harnesses and tether straps for damage and wear.
- ⚠** Warning:
- ⚠** Warning: Never leave a child unattended, even if the child is secured in a child safety seat.
- ⚠** Warning: Never use a child safety seat that has been involved in an accident. Have the seat inspected or replaced as a described in the child safety seat manufacturer's instructions.



Usage Restrictions

The optional Tesla built-in rear facing child seats are child restraint systems and must only be used for children over 37" (94 cm) tall and weighing between 35 and 77 lbs (16.2 to 35.2 kg).

Always ensure the top of the child's head cannot contact the vehicle and that the child is seated comfortably with the seat belts positioned and latched correctly. The child's pelvis must be held securely in place by the lap belt. Follow all instructions provided and do not use supplemental child safety seats in these seats.

Note: Whenever a child is seated in the Tesla built-in rear facing child seats, it is recommended that you set the climate control system to draw outside air into Model S instead of recirculating the air. This draws more air into the rear seating areas.

Opening

1. Remove the cover from the trunk floor and pull the strap to lift the seat assembly upward.

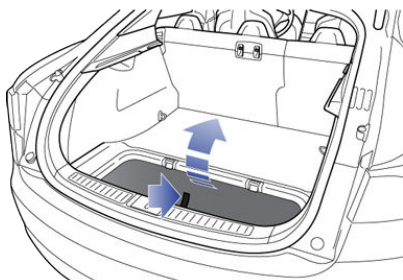

2. Push the seat assembly into position.

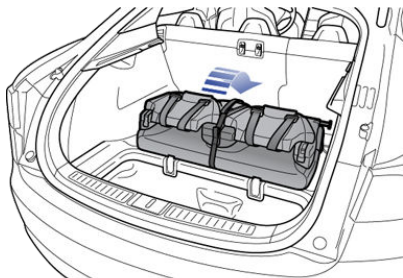

3. Undo the Velcro strap.

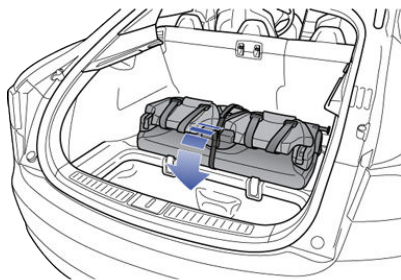

4. Pull the handle to release the head supports from the seat back, then pull the head supports toward you to unfold them.

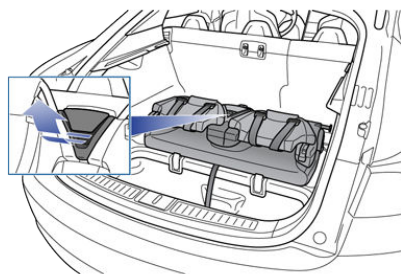

5. Raise the seat back to the upright position and push until it locks into position. Visually check to ensure that the retaining catches are engaged.

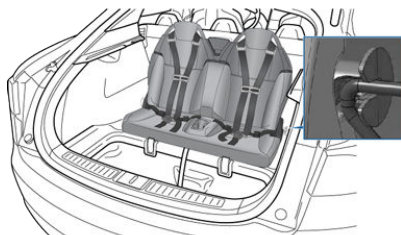

6. Check that the seat back and seat base are securely retained in the upright position by trying to pull the seat back toward you.

Folding

- ⚠ Caution:** Before folding the seats, fasten the seat belts to prevent them from getting trapped in the seat mechanism and being damaged.



Tesla Built-In Rear Facing Child Seats

1. Pull the handle to release the seat back and pull the seat back fully forward.

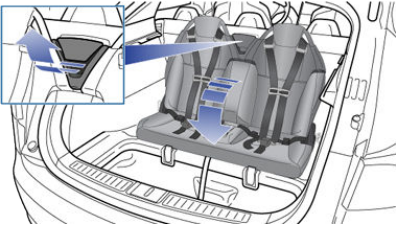

2. Push the lever to release the head supports from the seat back, then fold back onto the seat.

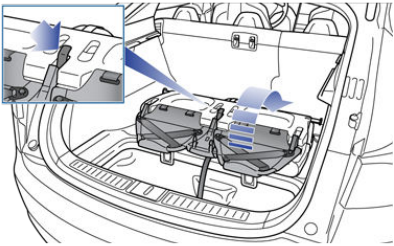

3. Secure the Velcro strap.

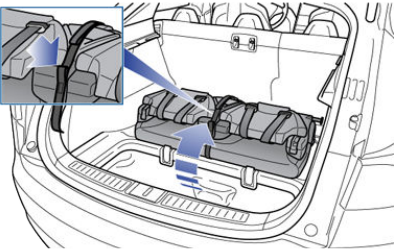

4. Pull the strap at the rear of the seat to fold the seat assembly into the trunk floor.

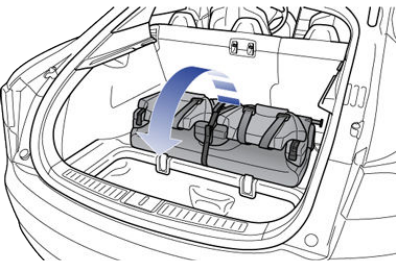

5. Replace the cover on the trunk floor.

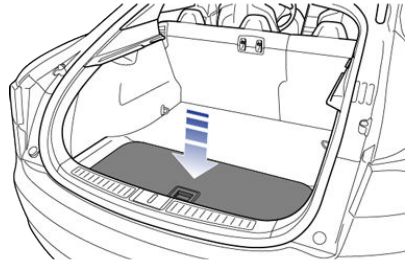



Seating a Child

The Tesla built-in rear facing child seats are child restraint systems and must only be used for children over 37" (94 cm) tall and weighing between 35 and 77 lbs (16.2 to 35.2 kg).

Always ensure the top of the child's head cannot contact the vehicle and that the child is seated comfortably with the seat belts positioned and latched correctly. The child's pelvis must be held securely in place by the lap belt. Follow all instructions provided and do not use supplemental child safety seats in these seats.

Note: Whenever a child is seated in the Tesla built-in rear facing child seats, it is recommended that you set the climate control system to draw outside air into Model S instead of recirculating the air. This draws more air into the rear seating areas.

1. Position the child in the seat with arms through the loops of the seat belts.
2. Connect the two halves of the seat belt tongue.
3. Insert the seat belt tongue into the buckle and ensure it is securely fastened.

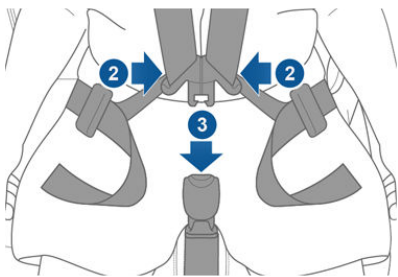

4. Adjust the shoulder belts so they run over the top of the child's shoulders and away from the face.
5. Connect the chest clip and adjust it to be as high as possible without causing the shoulder belts to touch the child's neck.

6. Pull the lower straps until the child is securely held in the seat.

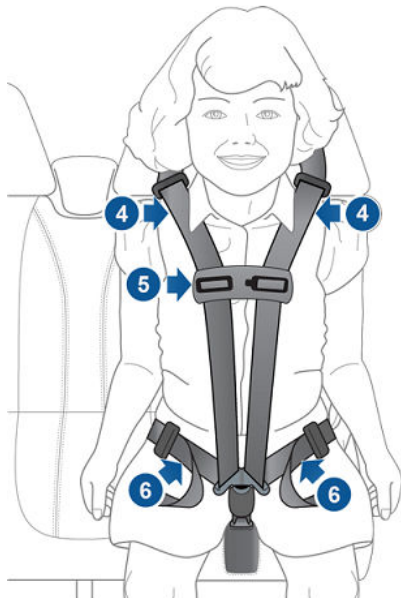



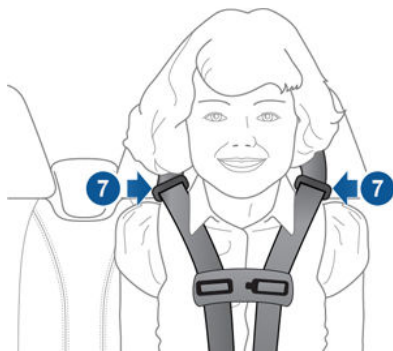









7. Slide the shoulder clips into place to ensure the upper portion of the belts remain positioned over the child's shoulders.



To release, press the button on the buckle, release the chest clip, and separate the two halves of the seat restraint.



Warnings - Tesla Child Seats

-  Warning: The Tesla built-in rear facing seats are child restraint systems and must only be used for children over 37" (94 cm) tall and weighing between 35 and 77 lbs (16.2 to 35.2 kg).
-  Warning: Do not use supplemental child restraint systems, including booster seats, in the Tesla built-in rear facing child seats.
-  Warning: Always ensure that the top of the child's head cannot touch the vehicle and that the child is seated comfortably with the seat belts correctly fastened.
-  Warning: Follow all instructions and heed all warnings related to the Tesla built-in rear facing child seats. Failure to do so can compromise occupant safety.
-  Warning: Read all safety warnings and labels attached to the seats.
-  Warning: Do not leave children unattended in Model S, even if the child is secured in a child safety seat or a Tesla built-in rear facing child seat. In hot weather, the interior temperature can reach dangerous levels that can result in dehydration, serious injury or death.
-  Warning: Do not remove or replace the fabric on a Tesla built-in rear facing child seat. The covers are an integral part of the restraint's performance and should not be removed or replaced with any other type than those supplied by Tesla.
-  Warning: If the Tesla built-in rear facing child seats have been worn in an accident, they must be inspected or replaced by Tesla, even if damage is not obvious.
-  Warning: Before allowing a child to ride in the Tesla built-in rear facing child seats, check that the seat is securely held in the upright position by trying to pull the seat back toward you.
-  Warning: Do not remove the built-in rear facing child seats for any reason, including cleaning. To ensure safety of occupants, removal and installation must be performed by qualified Tesla service technicians.
-  Warning: Do not make modifications or additions that can interfere with the operation of the Tesla built-in rear facing child seats.
-  Warning: To prevent injury, ensure all loose items (bags, luggage, etc.) are

secured. In an accident, or during hard braking and sharp turns, loose items could cause injury.



Location of Airbags

Airbags are located in the approximate areas shown here. Airbag warning information is printed on the sun visors.

Model S is equipped with an air bag and lap/shoulder belt at both front outboard seating positions. The air bag is a supplemental restraint at those seating positions. All occupants, including the driver, should always wear their seat belts whether or not an air bag is also provided at their seating position to minimize the risk of severe injury or death in the event of a crash.

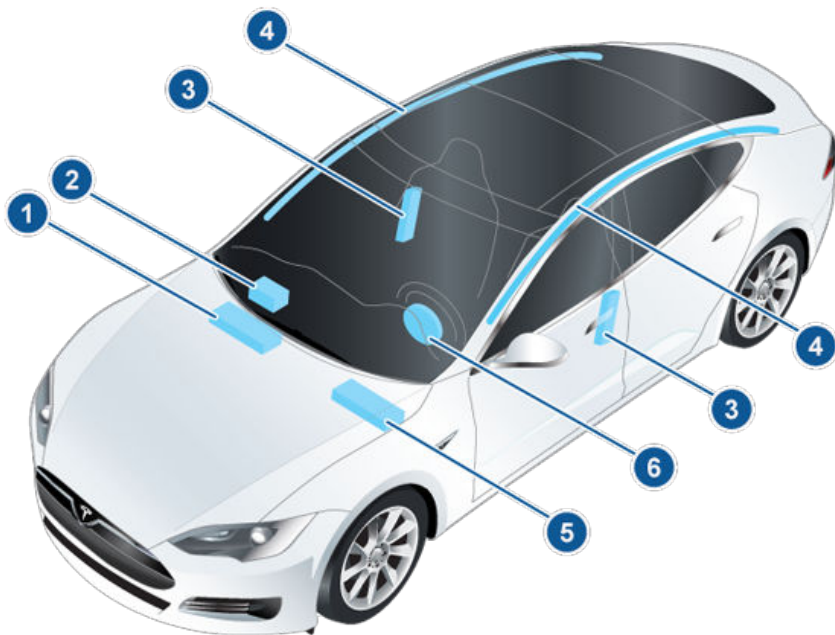

1. Passenger knee airbag
2. Passenger front airbag
3. Side airbags
4. Curtain airbags
5. Driver's knee airbag
6. Driver's front airbag



How the Airbags Work

Inflation of airbags depends on the rate at which the vehicle's cabin changes speed in a collision. The rate of deceleration determines whether airbags inflate.

Airbags inflate instantly with considerable force accompanied by a loud noise. The inflated bag, together with the seat belts, limits movement of occupants to reduce the risk of injury.

Front airbags are not ordinarily designed to inflate in rear collisions, rollovers, minor front or side collisions, heavy braking, or driving over bumps and potholes. Therefore, significant superficial damage can occur to the vehicle without the airbags inflating or, conversely, a relatively small amount of structural damage can cause airbags to inflate.

If you are planning to modify your vehicle for a person with disabilities in a way that may affect the airbag system, contact Tesla.

Types of Airbags

Model S has the following types of airbags:

- **Advanced front airbags:** The front airbags are advanced airbags designed to reduce airbag related injuries to children or small adults who ride in the front seats. On the driver's side, the front airbag works with a seat position sensor that adjusts the inflation level based on the seating position of the occupant. On the passenger's side, the airbag responds to a sensing system in the seat that determines whether or not the passenger side front airbag inflates, and optimizes the inflation level based on the weight of the occupant (described below).
- **Knee airbags:** Knee airbags and the front airbags work together. The knee airbags limit the forward motion of the front seat occupants by restricting leg movement, thereby positioning the occupants so that the front airbags work more effectively.
- **Side airbags:** Side airbags protect the thorax region of the torso and the pelvis. They inflate only if a severe side impact occurs. Side airbags on the non-impacted side of the vehicle do not inflate.
- **Curtain airbags:** Curtain airbags help protect the head and typically inflate only if a severe side impact occurs, or if the vehicle rolls over. Curtain airbags on both the impacted and non-impacted side of the vehicle will inflate.



Passenger Front Airbag

Model S has an occupancy sensor in the front passenger seat that controls the status of the airbags based on the weight of the occupant. Passenger airbag status displays in the top right corner of the touchscreen to indicate whether the airbag will inflate (on) or not inflate (off) if a collision occurs.

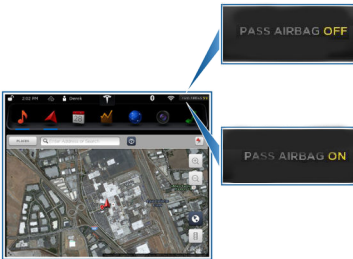

Note: The occupancy sensor system meets the regulatory requirement of FMVSS 208 and automatically detects when inflating the passenger front airbags would be unnecessary or potentially harmful.

Front passenger seat occupancy*	Passenger airbag status
Empty	OFF
Infant in child safety seat (up to 20 lbs/ 9kg)	OFF
Child or small occupant (20-100 lbs/9-45 kg)	ON or OFF
Heavy object/ occupant	ON
*Values are approximate. Occupants whose weight is close to the low weight threshold can cause the status to occasionally turn on and off depending on seating position and physique.	

Note: It takes approximately six seconds after you power on Model S for the occupancy sensor to report accurate status of the front passenger airbag. As a result, when you first power on Model S, the status defaults to PASS AIRBAG ON, even in situations when it should be OFF because the seat is either empty or carrying a weight of 20 lbs (9 kg) or less. However, after the six second initialization, the status should display as PASS AIRBAG OFF. If

it fails to do so, contact Tesla service immediately and seat passengers in the rear seating positions only.

If the status shows the airbag as permanently on, even when the seat is empty and the seat belt is unbuckled, contact Tesla immediately.

To make sure the sensing system can correctly detect occupancy status, eliminate the following:

- Objects lodged under the seat.
- Heavy objects sitting on the seat (briefcase, large purse).
- Objects wedged between the seat back and seat cushion.
- Cargo interfering with the seat.
- After market items attached to, or sitting on, the seat (covers, mats, blankets, etc.).

These conditions can interfere with the occupancy sensor. If you have eliminated the above possibilities, and the airbag status is still incorrect, ask passengers to ride in the rear seats and contact Tesla to have the airbag system checked.

Note: The front passenger seat's sensing system affects the operation of the passenger front and side airbags only. The other passenger airbags are not affected.

⚠ Warning: Never seat a child on the front passenger seat, even if the passenger airbag is off. All occupants age 12 and under must ride in the rear (second row) seats (see [Child Safety Seats](#) on page 22).

⚠ Warning: To ensure accuracy of the occupant detection system, do not make any modifications to the front passenger seat.

⚠ Warning: Do not use seat covers on Model S. Doing so could restrict deployment of the side air bags if an accident occurs. It can also reduce the accuracy of the occupant detection system.

Inflation Effects

When airbags inflate, a fine powder is released. This powder can irritate the skin and should be thoroughly flushed from the eyes and from any cuts or abrasions.

After inflation, the airbags deflate to provide a gradual cushioning effect for the occupants and to ensure the driver's forward vision is not obscured.



If airbags have inflated, or if your vehicle has been in an accident, always have the airbags, seat belt pre-tensioners and any associated components checked and, if necessary, replaced by Tesla.

In a collision, in addition to the airbags inflating:

- Doors unlock and the door handles extend.
- Hazard warning lights turn on.
- Interior lights turn on.
- High voltage is disabled.

To restore Battery power, use the touchscreen to manually power off Model S, then press the brake to power it back on again.

Airbag Warning Indicator



The airbag indicator on the instrument panel remains lit if the airbag system is malfunctioning. The only time this indicator should light up is briefly when Model S first powers up, in which case it turns off within a few seconds. If it remains lit, contact Tesla immediately and do not drive.

Airbag Warnings

- Warning: No objects should be placed over or near the air bag on the instrument panel, because any such objects could cause harm if the vehicle is in a crash severe enough to cause the air bag to inflate.
- Warning: All occupants, including the driver, should always wear their seat belts, whether or not an airbag is also provided at their seating position, to minimize the risk of severe injury or death in the event of a collision.
- Warning: Front seat occupants should not place their arms over the airbag module, as an inflating bag can cause fractures or other injuries.
- Warning: Do not use seat covers on Model S. Doing so could restrict deployment of the side air bags if an accident occurs. It can also reduce the accuracy of the occupant detection system.
- Warning: Airbags inflate with considerable speed and force, which can

cause injury. To limit injuries, ensure that occupants are wearing seat belts and are correctly seated, with the seat positioned as far back as possible. The National Highway Traffic Safety Administration (NHTSA) recommends a minimum distance of 10" (25 cm) between an occupant's chest and an airbag.

- Warning: Do not use a child safety seat or seat young children on a seat with an operational airbag in front of it. Doing so can cause injury or death if the airbag inflates.
- Warning: To ensure correct inflation of the side airbags, maintain an unobstructed gap between an occupant's torso and the side of Model S.
- Warning: Passengers should not lean their heads against the doors. Doing so can cause injury if a curtain airbag inflates.
- Warning: Do not allow passengers to obstruct the operation of an airbag by placing feet, knees or any other part of the body on or near an airbag.
- Warning: Do not attach or place objects on or near the front airbags, the side of the front seats, the headliner at the side of the vehicle, or any other airbag cover that could interfere with inflation of an airbag. Objects can cause serious injury if the vehicle is in a collision severe enough to cause the airbag to inflate.
- Warning: Following inflation, some airbag components are hot. Do not touch until they have cooled.



Creating a Driver Profile

If equipped with the driver profile feature, you only need to adjust Model S once. When you first adjust the driver's seat, steering wheel, or driver's side mirror (if equipped), the touchscreen prompts you to create a driver profile to save these adjustments. Your profile also saves some of the preferences you make using the touchscreen's Settings window.

A driver can add a new driver profile by touching Controls > Settings > Driver Profiles (or by touching the driver icon on the touchscreen's status bar, and touching Create Driver Profile). Enter the driver name and touch Create Profile.

If you change the position of the steering wheel, driver's seat, or driver's side mirror after you have saved a profile, the touchscreen prompts you to save the new position or restore the previously saved position (other preferences are automatically saved). To use a setting without saving or restoring, just ignore the prompt.

Note: Depending on date of manufacture, adjustments made to the driver's side mirror may not be saved to your driver profile.

Note: Valet Mode is a built-in driver profile used to limit speed and restrict access to some Model S features (see [Valet Mode](#) on page 35).

Note: Depending on date of manufacture and options selected at time of purchase, some Model S vehicles are not equipped with the Driver Profile feature. Also, in cases where the vehicle is equipped with Driver Profiles, some features may not be automatically saved and adjusted based on the driver profile (for example, mirror position).

Restoring a Driver's Profile



To adjust Model S based on a driver's profile, touch the driver profile icon, located to the left side of the Tesla "T" on the touchscreen's status bar. Then choose the driver and the saved adjustments are automatically made.

Saved Driver Settings

To see what settings are associated with your driver profile, touch Controls > Settings > Driver Profiles. Then touch See what's saved. A popup window lists the settings that are associated with a driver profile. These settings vary depending on the version of software currently running in Model S.

Valet Mode

When Model S is in Valet Mode, the following restrictions apply:

- Speed is limited to 70 mph (113 km/h).
- Maximum acceleration and power are limited.
- Front trunk and glove box are locked.
- The navigation system does not display Places (this protects Home/Work locations).
- Voice commands are disabled.
- Cruise control is disabled.
- Most status bar functions are disabled.
- The Mobile Access setting is disabled.
- HomeLink and Driver Profiles are not accessible.

Starting Valet Mode

With Model S in Park, touch the driver profile icon, located to the left of the Tesla "T" on the touchscreen's status bar, then touch Valet Mode.

The first time you start Valet Mode, you will be prompted to establish a 4-digit PIN that you will use to cancel Valet Mode.

When Valet mode is active, the instrument panel displays the word Valet above the driving speed and the Valet Mode driver profile displays on the touchscreen's status bar.

You can also use the Model S mobile app to start and cancel Valet Mode (provided Model S is in Park). When using the mobile app, you do not need to enter a PIN because you are already required to log into the app using your MY TESLA credentials.

Note: If you forget your PIN, reset it from inside Model S by entering your My Tesla credentials (which also cancels Valet Mode). You can also reset your PIN using the Model S mobile app.



Cancelling Valet Mode

With Model S in Park, touch the Valet Mode driver icon on the touchscreen's status bar, then enter the 4-digit PIN.

When you cancel Valet Mode, all settings associated with the most recently used Driver Profile and climate control settings are restored, and all features are available.

Note: You do not need to enter a PIN to cancel Valet Mode from the mobile app.

Adjusting Position

Adjust the steering wheel to the desired driving position by moving the control on the left side of the steering column. Using this control, you can move the steering wheel forward and backward and up and down.

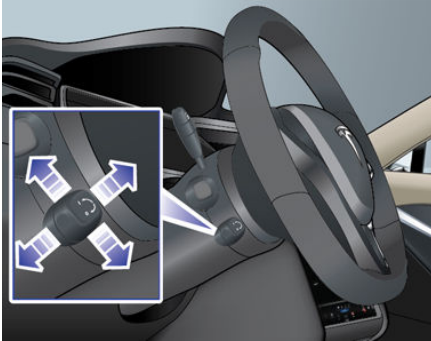

Warning: Do not make adjustments while driving.

Adjusting Sensitivity

You can adjust the feel and sensitivity of the steering system to suit your personal preference:

1. On the touchscreen, touch Controls.
2. Choose a steering option:
 - Comfort - reduces the effort required to turn the wheel. In town, Model S feels easier to drive and park.
 - Standard - Tesla believes that this setting offers the best handling and response in all conditions.
 - Sport - Increases the effort required to turn the wheel. When driving at higher speeds, Model S feels more responsive.

The only way to really know which option you like best is to try them.

Using Left Steering Wheel Buttons

Use the buttons on the left side of the steering wheel to change radio stations, control the media player's volume, and to choose what displays on the left side of the instrument panel (whenever the Navigation app is not displaying instructions).

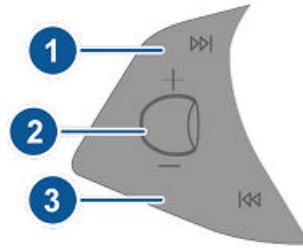

1. Next

If you are listening to local or satellite radio and you have defined more than one radio preset, press to play the next preset in the radio band that is currently playing. If you have not defined more than one preset, press to go to the next available frequency.

If you are listening to Internet radio, or to an audio file on a connected Bluetooth or USB device, press to skip to the next song or station.

2. Scroll Wheel

- To adjust the media volume, roll up or down.

Note: The scroll wheel adjusts the volume for media, navigation instructions and phone calls based on what is currently in use. As you adjust volume, the instrument panel displays the volume level and whether you are adjusting volume for media, navigation or phone.

- To mute the media volume, or to pause/play an audio file, tap the scroll wheel.
- To choose what displays on the left side of the instrument panel, press the scroll wheel briefly until the available options are displayed. Roll the scroll wheel to choose Empty, Car Status, Clock, Media, Energy or Trips, etc. When the option you want is highlighted, tap the scroll wheel.

Note: The option you choose to display using the left scroll wheel is retained until you manually change it. It is also saved in your driver profile.

3. Previous

Same as described above for Next, except it skips to the previous song or station.

Note: Regardless of how you customize the left side of the instrument panel, it



automatically changes to display navigation instructions (if applicable), or to let you know if a door or trunk is open when Model S is in a driving gear.

Using Right Steering Wheel Buttons

Use the buttons on the right side of the steering wheel to access call options while on a phone call, to browse the phonebook of a Bluetooth-connected phone, to choose what displays on the right side of the instrument panel, to adjust Model S features, and to use voice commands.

Note: Whenever you receive or make a phone call, the right side of the instrument panel automatically displays call options to help you easily handle phone calls on your Bluetooth-connected phone.

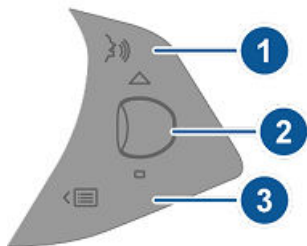

1. Touch to browse the phonebook of a Bluetooth-connected phone and touch again to close it.

Press and hold to use voice commands to call a contact, navigate, or listen to Internet music. When you hear the tone, speak your command. Release the button when you finish speaking. For details, see [Using Voice Commands](#) on page 39.

2. Scroll Wheel

- During a phone call, touch the scroll wheel to display call options that allow you to perform an action on the call, or access the phonebook.
- Roll the wheel to adjust the most recently used feature from the feature list (see Menu button).
- To choose what displays on the right side of the instrument panel, press the scroll wheel briefly until the available options are displayed. Roll the scroll wheel to choose Empty, Car Status, Clock, Media, Energy or Trips, etc. When the option you want is highlighted, tap the scroll wheel.

Note: The option you choose to display using the right scroll wheel is retained until you manually change it. It is also saved in your driver profile.

3. Menu button

Press to display a menu that allows you to control the following Model S features:

- All. Allows you to roll the wheel and choose from all available functions (listed next).
- Climate Temps. Roll the wheel to change the temperature, or press the wheel to turn the climate control system on and off.
- Fan Speed. Roll the wheel to adjust the speed of the fan used to cool or heat the cabin.
- Display Brightness. Roll the wheel to change the brightness level of the displays, or press the wheel to restore default settings.
- Sunroof (if equipped). Roll the wheel to adjust the position of the sunroof.
- Media Source. Roll the wheel to control what Media Player is playing, or press the wheel to add/remove the currently playing station or audio track as a Favorite.

Press the menu button again to close the feature list.



Using Voice Commands

You can use voice commands to call a contact, navigate, or listen to Internet music. Press and hold the voice button on the upper right side of the steering wheel. When you hear the tone, speak your command while continuing to hold down the voice button. Release the button when you finish speaking.

- To call a contact on your Bluetooth-connected phone, say “Call” or “Dial,” followed by the contact’s first and/or last name(s). For example, “Call Joe” or “Call Joe Smith.”
- To search for, or navigate to, a location, say “Where is,” “Drive,” or “Navigate,” followed by an address, business name, business category, or landmark. For example, “Drive to Tesla in Menlo Park,” “Drive to Starbucks on Homestead in Cupertino,” or “Where is Stanford University?” If you have defined a navigation address for your home or work locations, you can use a voice command to “Navigate home” or “Navigate to work.”
- To listen to an Internet music service, say “Listen to,” or “Play,” followed by the name of the song, album, artist or combination. To improve voice recognition accuracy, provide multiple cues in your command, such as artist plus song (for example, “Play Yellow Brick Road by Elton John” or “Listen to Yellow Brick Road”).

Note: You can also use voice commands to provide feedback to Tesla. Say “Note”, “Report”, “Bug note”, or “Bug report” followed by your brief comments. Model S takes a snapshot of its systems, including screen captures of the touchscreen and instrument panel. Tesla periodically reviews these notes and uses them to continue improving Model S.

Heated Steering Wheel

If Model S is equipped with the optional cold weather package, you can access a control that instantly warms up the steering wheel by touching Controls > Cold Weather > Heated Wheel. When turned on, a heater in the steering wheel provides radiant heat that keeps the steering wheel at a comfortable temperature.

Horn

To sound the horn, press the center pad on the steering wheel.





Adjusting Exterior Side Mirrors

Press the button associated with the mirror you want to adjust (left or right). The button's light turns on and you can then press the dial to move the mirror to the desired position. Repeat for the other side mirror. If prompted, touch Save on the touchscreen to save the mirror adjustment in your driver profile.

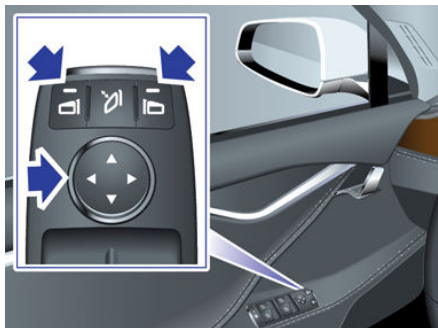

To fold exterior mirrors, press the center button. To set the mirrors to fold automatically whenever you Model S is locked, touch Controls > Settings > Vehicle > Mirror Auto-Fold > ON.

Note: If mirrors are folded, they automatically unfold when your driving speed exceeds 25 mph (40 km/h). In addition, you can not fold a mirror when exceeding this speed.



The driver's side mirror automatically dims at night, in proportion to the level of glare from the headlights of a vehicle behind you (except when in Reverse gear). Also, both exterior side mirrors have heaters that turn on and off with the rear window defroster.

Note: Depending on date of manufacture and options selected at time of purchase, some Model S vehicles are not equipped with a side

mirror that automatically dims at night and may not include heated side mirrors. In addition, mirror adjustments may not be saved to your driver profile.

Mirror Auto-tilt When Reversing

Both exterior mirrors can automatically tilt downward when backing up. To adjust the auto-tilt position, shift into Reverse, then adjust the mirrors as described above (press the button associated with the mirror you want to adjust, then press the dial to move the mirror to the desired position). Touch Save on the touchscreen to save the mirror adjustment in your driver profile.

When you shift back into Drive, the mirrors tilt back to their normal (upward) position. But now that you have adjusted them for backing up, they automatically tilt to the selected downward position whenever you shift into Reverse.

You can turn the auto-tilt feature on or off using the touchscreen, Touch Controls > Settings > Vehicle > Mirror Auto-Tilt.

Note: Depending on date of manufacture and options selected at time of purchase, some Model S vehicles are not equipped with Mirror Auto-Tilt.

Rear View Mirror

Except when in Reverse gear, the rear view mirror automatically dims in proportion to the level of glare from the headlights of a vehicle behind you.



Starting

When you open a door, Model S powers on the instrument panel and touchscreen. The center circle on the instrument panel displays the status of doors and the charge level, and you can operate all controls.

To drive:

- PRESS THE BRAKE - the center circle on the instrument panel changes to display the speedometer, power meter, charge level, and selected gear (P, R, N, or D).
- SELECT A GEAR - all the way down for Drive and all the way up for Reverse.

Everything you need to know when driving Model S displays on the instrument panel.

Key Not Inside

If Model S does not detect a key when you press the brake, the instrument panel displays a message telling you that a key was not detected.

Place the key in the center console cup holder where Model S can best detect it.

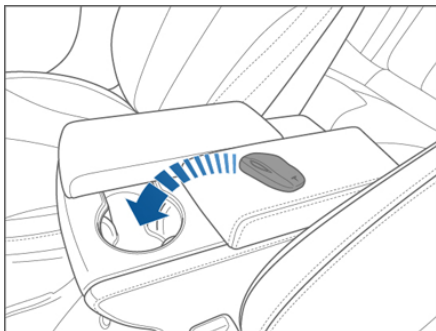

If Model S still does not detect the key, try holding it against the center console, immediately below the 12V power socket (see [12V Power Socket](#) on page 113). Or try using another key. If another key does not work, contact Tesla.

A number of factors can affect whether Model S can detect the key. These include a low battery in the key, interference from other devices using radio signals, and objects between the key and receiver.

Always keep the key with you. After driving, you need it to restart Model S after it powers off. And when you leave Model S, you must bring it with you to lock Model S, either manually or automatically (see [Walk-away Locking](#) on page 7).

Powering Off

When you finish driving, shift into Park by pressing the button on the end of the gear selector. The parking brake automatically engages and all systems keep operating. When you leave Model S with the key, it powers off automatically, turning off the touchscreen and instrument panel.

Model S also powers off automatically after being in Park for 15 minutes, even if you are sitting in the driver's seat.

Although usually not needed, you can power off Model S while you are still sitting in the driver's seat. Touch Controls > E-Brake & Power Off > Power Off. Model S automatically powers back on again if you press the brake or touch anywhere on the touchscreen.

Note: Model S automatically shifts into Park whenever you leave the vehicle, even if you shift into Neutral before exiting. To keep Model S in Neutral, see [Keeping Your Vehicle in Neutral \(Tow Mode\)](#) on page 42.



Shifting Gears

When Model S is in Park, you must press the brake to shift to another gear.

Move the lever up or down to change gears.

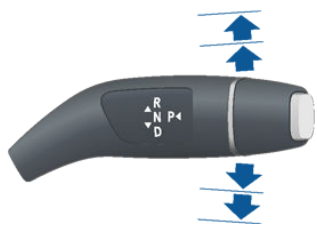

If you try to shift into a gear that the current driving speed prohibits, you will hear a chime and the gear does not change.

Reverse

Push the lever all the way up and release. You can only shift into Reverse when Model S is stopped or moving less than 5 mph (8 km/h). If moving less than 1 mph (1.6 km/h), you must press the brake.

Neutral

Push the lever up or down to the first position and release to shift into Neutral. Neutral allows Model S to roll freely.

If Model S is in Park and you use the touchscreen to release the parking brake (Controls > E-Brake & Power Off), Model S shifts into Neutral (see [Parking Brake](#) on page 55).

Model S automatically shifts into Park when you exit. To leave Model S in Neutral, use the touchscreen to engage Tow mode (see [Keeping Your Vehicle in Neutral \(Tow Mode\)](#) on page 42).

Drive

Push the lever all the way down and release. You can shift into Drive when Model S is stopped or moving less than 5 mph (8 km/h) in Reverse. If Model S is moving less than 1 mph (1.6 km/h), you must press the brake to shift into Drive.

Park

With Model S stopped, press the end of the gear selector. Whenever Model S is in Park, the parking brake is applied.



Model S automatically shifts into Park whenever you:

- Leave the vehicle.
- Connect a charge cable.

To make it convenient to pick up passengers, you can also unlock all doors and/or extend the door handles at any time by shifting into the Park gear then pressing the Park button a second time.

Keeping Your Vehicle in Neutral (Tow Mode)

Model S automatically shifts into Park whenever you finish driving and leave Model S. To keep Model S in Neutral when you exit, allowing it to roll freely (for example, pulling onto a transporter, etc.), activate Tow mode:

1. Shift into Park.
2. Press the brake pedal.
3. Touch Controls > Settings > Service & Reset > Tow Mode.

Model S beeps, and shifts into Neutral (which releases the parking brake).



When Tow mode is active, Model S displays this indicator light on the instrument panel, along with a message telling you that Model S will remain free rolling.

Note: In Tow mode, Model S does not shift into a driving gear. To cancel Tow mode, shift into Park or touch Tow mode again. Tow mode also cancels if you use the touchscreen to apply the parking brake (Controls > E-Brake & Power Off > Parking Brake).



Instrument Panel Overview

The instrument panel changes depending on whether Model S is:





- Off (shown below).
- Driving (see [Instrument Panel - Driving](#) on page 46).
- Charging (see [Charging Status](#) on page 133).

When Model S is off, the instrument panel shows remaining estimated range, status of doors, and outside temperature. When you press the brake, indicator lights flash on briefly along the top. Unless an indicator light applies to a current situation, it should turn off. If an indicator light fails to turn on or off, contact Tesla.











Note: The following illustration is provided for demonstration purposes only. Depending on vehicle options, software version, and market region, the information displayed may be slightly different.









The following indicators illuminate on the instrument panel to advise you or alert you of a specific condition.

Indicator	Description
	Low beam headlights are on.
	High beam headlights are on. Illuminates on a Model S that is equipped with the optional Autopilot Tech Package only in situations where high beams are on but the Auto High Beam setting is turned off. See High Beam Headlights on page 51.
	High beam headlights are currently turned on, and Auto High Beam is ready to turn off the high beams if light is detected in front of Model S. See High Beam Headlights on page 51.
	High beam headlights are temporarily turned off because Auto High Beam is on and is detecting light in front of Model S. When light is no longer detected, the high beams will automatically turn back on. See High Beam Headlights on page 51.



Indicator	Description
	Parking lights (side marker lights, tail lights, and license plate lights) are on. See Lights on page 48.
	Front fog lights (optional). See Lights on page 48.
	Electronic stability control systems are actively minimizing wheel spin by controlling brake pressure and motor power (indicator flashes). See Traction Control on page 56. If this indicator stays illuminated, a fault is detected (contact Tesla immediately).
	Smart Air Suspension's automatic self-leveling is disabled. In other words, Model S is in Jack mode and is ready to be lifted or pulled onto a transporter. Jack mode cancels when Model S is driven over 4.5 mph (7 km/h). See Smart Air Suspension on page 108.
	A Smart Air Suspension fault is detected. Contact Tesla. See Smart Air Suspension on page 108.
	A brake system fault is detected or the brake fluid level is low. See Brakes on page 54. Contact Tesla immediately.
	Airbag safety. If this indicator does not flash on briefly when Model S prepares to drive, or if it remains on, contact Tesla immediately. See Airbag Warning Indicator on page 34.
	An ABS (Anti-lock Braking System) fault is detected. See Brakes on page 54. Contact Tesla immediately.
	The parking brake is manually applied. See Parking Brake on page 55.
	A parking brake fault is detected. Contact Tesla. See Parking Brake on page 55.
	Vehicle Hold is actively applying the brakes. See Vehicle Hold on page 59.



Indicator	Description
	Tire pressure warning. The pressure of a tire is out of range. If a fault with the Tire Pressure Monitoring System (TPMS) is detected, the indicator flashes. For a TPMS fault, contact Tesla. See Tire Care and Maintenance on page 135.
	A door or trunk is open. See Door handles .
	A seat belt for an occupied seat is not fastened. Note: Depending on the date of manufacture, rear seating positions may not be equipped with a seat belt reminder. See Seat Belts on page 19.
	Electronic stability control systems are no longer minimizing wheel spin (i.e. on a single motor vehicle, the traction control system has been turned off, or on a dual motor vehicle, Slip Start has been enabled). See Traction Control on page 56.
	Model S is in Tow mode and can roll freely. It does not automatically shift into Park when you exit. See Instructions for Transporters on page 175.
	Flashes green when the left turn signal is operating. Both turn signal indicators flash green when the hazard warning flashers are operating.
	Flashes green when the right turn signal is operating. Both turn signal indicators flash green when the hazard warning flashers are operating.



Instrument Panel - Driving

When Model S is driving (or ready to drive), the instrument panel shows your current driving status and a real-time visualization of the road as detected by Model S's Autopilot components (see [About Driver Assistance](#) on page 65).

Note: The following illustration is provided for demonstration purposes only. Depending on vehicle options, software version, and market region, the information displayed may be slightly different.

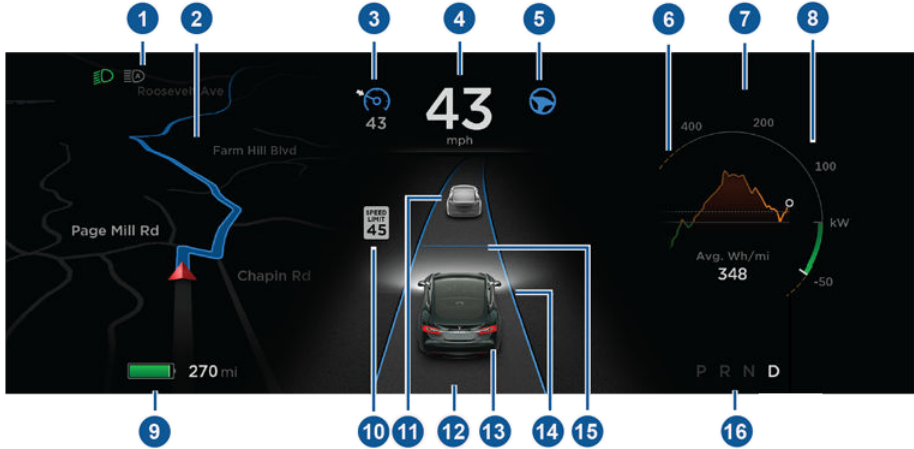

1. Indicator lights display along the top to provide status (see [Instrument Panel](#) on page 43).
2. When you are actively navigating to a destination, navigation instructions display here. Use the left steering wheel buttons to change what displays on the left side of the instrument panel whenever navigation instructions are not displayed (see [Using Left Steering Wheel Buttons](#) on page 37).
3. Traffic-Aware Cruise Control is cruising at a set speed. When Traffic-Aware Cruise Control is available but you haven't set a cruising speed, the icon is gray and the speed is not shown (see [Traffic-Aware Cruise Control](#) on page 68).
4. Driving speed.
5. Autosteer is actively steering Model S. When Autosteer is available but you haven't activated it, the icon is gray (see [Autosteer](#) on page 74).
6. On the Energy graph, dashed lines appear on the power meter if Model S is limiting power. The dashed lines appear on the top portion (energy being used) when power available for acceleration is being limited, and on the bottom portion (energy being gained) when power that can be gained by regenerative braking is limited. Model S limits power for many reasons. Here are just a few examples:
 - Acceleration may be limited when the Battery is reaching a low state of charge or if the powertrain is hot.
 - Both acceleration and regenerative braking may be limited when the ambient temperature is either very high or very low.
 - Regenerative braking may be limited when the Battery is fully charged.

Note: Use the right steering wheel buttons to control what displays on the right side of the instrument panel (see [Using Right Steering Wheel Buttons](#) on page 38).

7. Pay attention to important alert messages that display here. If any alerts are in effect, you can view information about them by touching the alert icon (exclamation mark) on the touchscreen's status bar (the topmost area of the touchscreen).



8. Use the right steering wheel buttons to change what displays on the right side of the instrument panel whenever a phone call is not active (see [Using Left Steering Wheel Buttons](#) on page 37).
9. Total estimated driving distance (or energy) available. Instead of driving distance, you can display the percentage of battery energy remaining. To do so, touch Controls > Settings > Units & Format > Energy & Charging (see [Settings](#) on page 99).

Note: When anticipating when you need to charge, use range estimates as a general guideline only.

Note: In cold weather, some of the stored energy in the Battery may not be available on your drive because the Battery is too cold. When this happens, a portion of the Battery meter is blue and the driving distance value has a snowflake image next to it. If Model S is plugged in, you can heat your Battery using wall power by turning on climate control using the mobile app. When the Battery warms up, the blue portion on the meter and the snowflake image are no longer displayed.

10. The speed limit (if available) that is currently being detected by Speed Assist (see [Speed Assist](#) on page 88).
11. The car in front of you (if applicable).
12. Pay attention to important driving-related messages that appear at the bottom center of the instrument panel.
13. Your Model S.
14. When Autosteer is active, the driving lane is highlighted in blue (see [Autosteer](#) on page 74). The lane may highlight in red if a front wheel passes over a lane marking and the associated turn signal is off (see [Lane Assist](#) on page 83).
15. The following distance that Traffic-Aware Cruise Control will maintain from the car in front of you. You can adjust the following distance as appropriate for driving conditions (see [Traffic-Aware Cruise Control](#) on page 68).
16. Currently selected gear: Park, Reverse, Neutral, or Drive.



Controlling Lights

Touch Controls on the bottom corner of the touchscreen to control most of the lights.

In addition to the lights that you can control from the touchscreen, Model S has convenience lights that turn on and off automatically based on what you are doing. For example, you will notice interior lights, marker lights, tail lights, door handle lights, and puddle lights that turn on when you unlock Model S, when you open a door, and when you shift into Park. They turn off automatically after a minute or two or when you shift into a driving gear or lock Model S.

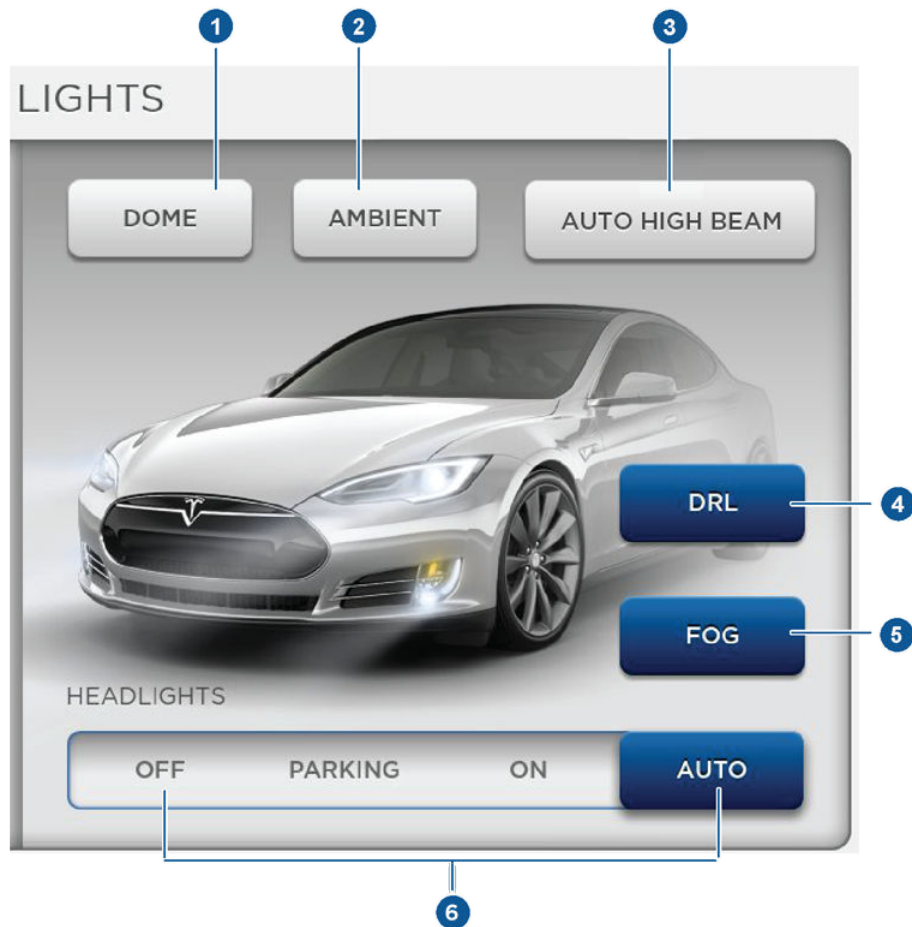



1. If you turn on DOME lights, all interior dome (map) lights turn on when you unlock Model S, open a door upon exiting, or shift into P (Park). They turn off after 60 seconds, when you lock Model S, or when you shift into a driving gear. If set to AUTO, dome lights turn on only when little or no light is detected.

You can also manually turn an individual dome light on or off by pressing its lens. If you manually turn a dome light on, it turns off when Model S powers off. If Model S was already powered off when you manually turned the light on, it turns off after 60 minutes.

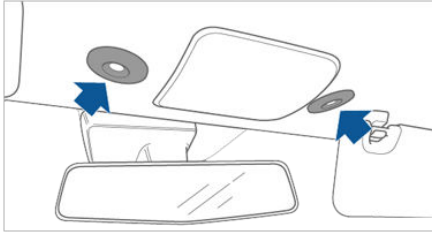

2. If you turn on AMBIENT lights, the lights on the door armrests turn on whenever the headlights are on.
3. If you turn on AUTO HIGH BEAM, high beam headlights turn on and off automatically based on whether or not light is detected in front of Model S (see [High Beam Headlights](#) on page 51). This feature is available only if Model S is equipped with the optional Autopilot Tech Package.
4. DRL (Daytime Running Lights) operate only when driving with the headlights off. In jurisdictions where required by law (Canada), daytime running lights can not be turned off.
5. If Model S is equipped with optional front fog lights, touch to turn them on or off.



The Front Fog indicator displays on the instrument panel whenever the optional front fog lights are on.

The fog lights operate only when low beam headlights are on. Whenever headlights are turned off, fog lights also turn off.



6. Exterior lights are set to AUTO each time you start Model S. Touch these options to temporarily change the exterior light setting:

OFF	All exterior lights (headlights, tail lights, side marker lights, parking lights, and license plate lights) turn off until you manually turn them back on or until the next time you drive Model S.
PARKING	Only the side marker lights, parking lights, tail lights and license plate lights turn on.
ON	All exterior lights (headlights, tail lights, side marker lights, parking lights, and license plate lights) turn on.
AUTO	All exterior lights (headlights, tail lights, side marker lights, parking lights, and license plate lights) turn on automatically when driving in low lighting conditions. If you change to a different setting, lights always revert to this AUTO setting on your next drive.

Note: Optional fog lights operate automatically whenever the low beam headlights are on. When headlights are off or high beam headlights are on, fog lights are also off.



High Beam Headlights

Push the left-hand steering column lever away from you. To cancel, pull the lever toward you.





If Model S is equipped with Driver Assistance components (see [About Driver Assistance](#) on page 65), and you have purchased the optional Autopilot Tech Package, the high beam headlights can automatically switch to low beam when there is light detected in front of Model S (for example, from an oncoming vehicle or street lights). To turn this feature on, touch Controls > Auto High Beam.

Note: Your chosen setting is retained until you manually change it. It can also be saved in your driver profile.

In situations where high beams are turned off because Auto High Beam is turned on and light is detected in front of Model S, you can temporarily turn on high beams by pulling the lever all the way toward you.

The following indicator lights are visible on the instrument panel when high beams are turned on:

-  High beams are turned on and the Auto High Beam setting is turned off.
-  High beams are currently turned on, and Auto High Beam is ready to turn off the high beams if light is detected in front of Model S.
-  High beams are temporarily turned off because Auto High Beam is on and is detecting light in front of Model S. When light is no longer detected, the high beams will automatically turn back on.

To flash the headlight high beams, pull the lever fully toward you and release.

-  **Warning:** Auto High Beam is an aid only and is subject to limitations. It is the driver's responsibility to make sure that

the headlights are always adjusted as appropriate for the weather conditions and driving circumstances.

Headlights After Exit

When you stop driving and park Model S in low lighting conditions, the exterior lights automatically turn on. They automatically turn off after one minute or when you lock Model S.

You can turn this feature on and off using the touchscreen. Touch Controls > Settings > Vehicle > Headlights After Exit. When Headlights After Exit is set to Off, the headlights turn off when you engage the Park gear.

Turn Signals

Move the left-hand steering column lever up (before turning right) or down (before turning left).



The turn signals stop operating when canceled by the steering wheel, or when you return the lever to the central position.

-  The corresponding turn signal indicator lights up on the instrument panel when a turn signal is operating. You also hear a clicking sound.

-  **Warning:** If Model S is equipped with both Autopilot hardware and the optional Autopilot Tech Package, engaging a turn signal can cause Model S to accelerate when using Traffic-Aware Cruise Control in specific situations (see [Overtake Acceleration](#) on page 71).



Lane Change Flash

To indicate a lane change, quickly press the lever up or down against the spring pressure, then release. The corresponding turn signal flashes three times.

Hazard Warning Flashers

To turn on the hazard warning flashers, press the button located on the side of the touchscreen closest to the steering wheel. All turn signals flash. Press again to turn off.

Note: Hazard warning flashers operate even without a Model S key nearby.



Wipers

To wipe the windshield, rotate the end of the left-hand steering column lever away from you. You can choose from four levels:

- 1st: Auto with low rain sensitivity.*
- 2nd: Auto with high rain sensitivity.*
- 3rd: Continuous, slow.
- 4th: Continuous, fast.



For a single wipe, press and release the end of the lever.

If the wipers are set to Auto and the sensor detects no water, the wipers do not wipe.

When you operate the wipers, headlights automatically turn on (if they are not on already).

*Model S has a rain sensor located on the inside of the windshield at the base of the interior mirror. When wipers are set to Auto, the frequency at which they wipe depends on how much water the sensor detects. When wipers are set to the 2nd level, the sensor is more sensitive.

To extend the life of wiper blades, remove ice from the windshield before turning wipers on. Ice has sharp edges that can damage the rubber on the blades.

Periodically check and clean the edge of the wiper blade. If damaged, replace the blade immediately. For details on checking and replacing wiper blades, see [Wiper Blades and Washer Jets](#) on page 147.

! Caution: In harsh climates, ensure that the wiper blades are not frozen or adhered to the windshield.

De-icing Wipers

To make wiper blades easy to access so you can remove any ice and snow, shift Model S into Park, then use the touchscreen to move them to the service position. Touch Controls > Settings > Service & Reset > Service Mode > ON. When parking in cold outdoor climates, it is helpful to leave Model S with the wipers in the service position. In this position, they are closer to the defrost vent, allowing you to thaw them by directing air from the climate control system towards the windshield.

Note: Wipers automatically return to their normal position when you shift Model S out of Park.

If Model S is equipped with the optional cold weather package, you can de-ice wipers by touching Controls > Cold Weather > Heated Wipers. Wiper heaters automatically turns off after 15 minutes.

Washers

Press the button on the end of the left steering column lever to spray washer fluid onto the windshield. You can press this button at two levels. Press partially for a single wipe, without any washer fluid. Press fully for both wipe and wash. When washing the windshield, the wipers will perform two wipes after you release the button, then a third wipe a few seconds later.



Periodically top up washer fluid (see [Topping Up Washer Fluid](#) on page 151).

De-icing Washer Nozzles

If Model S is equipped with the optional cold weather package, washer nozzles have de-icers that turn on whenever the ambient temperature nears freezing, or when you turn on the heated wipers (Controls > Cold Weather > Heated Wipers). The washer de-icers turn off when the heated wipers turn off (after 15 minutes), provided the temperature is warm enough to prevent freezing.



Braking Systems

Model S has an anti-lock braking system (ABS) that prevents the wheels from locking when you apply maximum brake pressure. This improves steering control during heavy braking in most road conditions.

During emergency braking conditions, the ABS constantly monitors the speed of each wheel and varies the brake pressure according to the grip available.

The alteration of brake pressure can be felt as a pulsing sensation through the brake pedal. This demonstrates that the ABS is operating and is not a cause for concern. Keep firm and steady pressure on the brake pedal while experiencing the pulsing.



The ABS indicator flashes briefly on the instrument panel when you first start Model S. If this indicator lights up at any other time, an ABS fault has occurred and the ABS is not operating. Contact Tesla. The braking system remains fully operational and is not affected by an ABS failure. However, braking distances may increase.



If the instrument panel displays this indicator at any time other than displaying briefly when you first start Model S, a brake system fault is detected or the brake fluid level is low. Contact Tesla immediately.

Emergency Braking

In an emergency, fully press the brake pedal and maintain firm pressure, even on low traction surfaces. The ABS varies the braking pressure to each wheel according to the amount of traction available. This prevents wheels from locking and ensures that you stop as safely as possible.



Warning: Do not pump the brake pedal. Doing so interrupts operation of the ABS and can increase braking distance.



Warning: Always maintain a safe distance from the vehicle in front of you and be aware of hazardous driving conditions. While the ABS can improve stopping distance, it cannot overcome the laws of physics. It also does not prevent the danger of hydroplaning (where a layer of water prevents direct contact between the tires and the road).

If Model S is equipped with Autopilot hardware, Automatic Emergency Braking automatically applies full braking in situations where a collision is considered imminent (see [Automatic Emergency Braking](#) on page 86).

Brake Wear

Model S brake pads are equipped with wear indicators. A wear indicator is a thin metal strip attached to the brake pad that squeals as it rubs against the rotor when the pad wears down. This squealing sound indicates that the brake pads have reached the end of their service life and require replacement. To stop the squealing, contact Tesla Service.



Warning: Neglecting to replace worn brake pads results in damage to the braking system and can create a braking hazard.



Regenerative Braking

Whenever Model S is moving and your foot is off the accelerator, regenerative braking slows down Model S and feeds any surplus energy back to the Battery.

By anticipating your stops and simply removing pressure from the accelerator to slow down, you can take advantage of regenerative braking to increase driving range. Of course, this is no substitute for regular braking when needed for safety.

Note: If regenerative braking is aggressively slowing Model S, such as on a steep descent, brake lights turn on to alert other road users that you are slowing down.

The Energy app displays real-time feedback on the amount of energy being gained by regenerative braking. You can also display the power meter on either side of the instrument panel by choosing Energy using the scroll button on the steering wheel (see [Steering Wheel](#) on page 37).

The amount of energy fed back to the Battery using regenerative braking can depend on the current state of the Battery and the charge level setting that you are using. If regenerative braking is limited, a dashed yellow line displays on the power meter. For example, regenerative braking may be limited if the Battery is already fully charged or if the ambient temperature is low.

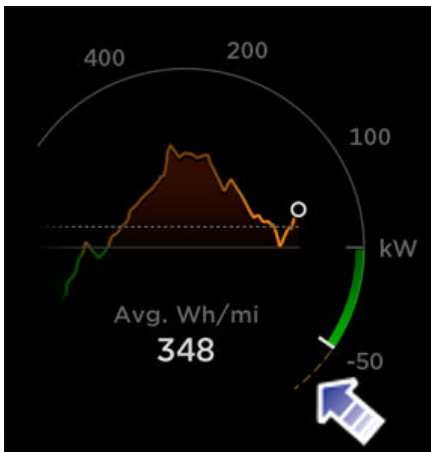

To Set the Regenerative Braking Level

You can use the touchscreen to change the level of regenerative braking:

1. Touch Controls > Driving > Regenerative Braking.
2. Choose from two levels:
 - Standard. Provides the maximum amount of regenerative braking. When you release the accelerator, Model S slows down faster, reducing the need to use the brakes.
 - Low. Limits regenerative braking. When you release the accelerator, Model S takes longer to slow down and coasts further.

Parking Brake

The parking brake automatically engages when you shift Model S into Park, and releases when you shift into any other gear.



Note: The parking brake operates on the rear wheels only, and is independent of the foot-operated brake system.

Use the touchscreen to manually release the parking brake (which also shifts Model S into Neutral):

1. Touch Controls > E-Brake & Power Off.
2. Press the brake pedal, then touch Parking Brake. If Model S was previously in Park, it shifts into Neutral.



The parking brake indicator lights up on the instrument panel whenever you use the touchscreen to manually apply the parking brake.



If an electrical issue occurs with the parking brake, an amber parking brake fault message displays at the top center of the touchscreen.



Caution: In the unlikely event that Model S loses electrical power, you cannot release the parking brake.



How It Works

The traction control system constantly monitors the speed of the front and rear wheels. If Model S experiences a loss of traction, the system minimizes wheel spin by controlling brake pressure and motor power. By default, the traction control system is always active. Under normal conditions, it should remain active to ensure maximum safety.

On standard (single motor) Model S vehicles, traction control can be turned off at any time. Turn it off only in circumstances where you deliberately want the wheels to spin, such as when Model S is stuck in snow or mud.

On a dual motor Model S, you can enable slip start to allow the wheels to spin at a limited speed. Slip start can be enabled only when Model S is moving 20 mph (32 km/h) or slower. Slip start automatically disables when the speed exceeds 40 mph (64 km/h).



This indicator flashes on the instrument panel whenever the traction control system is actively controlling brake pressure and motor power to minimize wheel spin. If the indicator stays on, a fault is detected with the traction control system. Contact Tesla Service.

 Warning: Traction control can not prevent accidents caused by driving dangerously or turning too sharply at high speeds.

 Warning: If the above indicator remains illuminated without turning off traction control (single motor vehicles) or enabling slip start (dual motor vehicles), the traction control system may not be operating correctly. Contact Tesla Service immediately.

Disabling Traction Control (single motor vehicles)

Under normal conditions, the traction control system should remain enabled. Disable it only in circumstances where you deliberately want the wheels to spin, such as:

- Starting on a loose surface, such as gravel or snow.
- Driving in deep snow, sand or mud.
- Rocking out of a hole or deep rut.

To allow the wheels to spin on a single motor Model S, touch Controls > Driving > Traction Control > Off.



The instrument panel displays an alert message when traction control is turned off.

Although the traction control system automatically reactivates the next time you start Model S, it is strongly recommended that you enable it immediately after the circumstances that required you to disable it have passed.

Allowing Wheel Slip (dual motor vehicles)

To allow the wheels to slip at a limited speed, you can enable Slip Start. Slip Start can be enabled only when Model S is moving 20 mph (32 km/h) or slower. Slip Start automatically disables when the speed exceeds 40 mph (64 km/h).

Under normal conditions, Slip Start should not be enabled. Enable it only in circumstances where you deliberately want the wheels to slip, such as:

- Starting on a loose surface, such as gravel or snow.
- Driving in deep snow, sand or mud.
- Rocking out of a hole or deep rut.

To allow the wheels to slip on a dual motor Model S, touch Controls > Driving > Traction Control > Slip Start.



The instrument panel displays an alert message when Slip Start is enabled.

Although the traction control system automatically reactivates the next time you start Model S, it is strongly recommended that you enable it immediately after the circumstances that required you to enable Slip Start have passed.



How Park Assist Works

Model S has several sensors designed to detect the presence of objects nearby. When moving slowly in Drive or Reverse, the sensors alert you if an object is detected in close proximity to the front and rear of your Model S.

Note: Depending on date of manufacture and options selected at time of purchase, some Model S vehicles are not equipped with the parking sensors.

⚠ Warning: The Park Assist images provided below are representative only. The exact number and location of sensors may vary depending on the date your Model S was manufactured.



The sensors are activated when driving less than 5 mph (8 km/h).

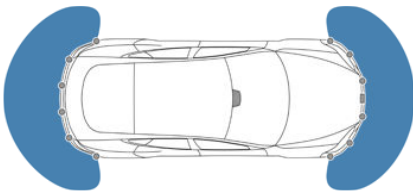

⚠ Warning: Never depend on Park Assist to inform you if an area you are approaching is free of objects and/or people. Several external factors can reduce the performance of Park Assist, causing

either no readings or false readings (see [Limitations and False Warnings](#) on page 58). Therefore, depending on Park Assist to determine if Model S is approaching an obstruction can result in damage to the vehicle and/or objects, and can potentially cause serious injury. Always inspect the area with your own eyes. When reversing, perform shoulder checks and use all mirrors. Park assist does not detect children, pedestrians, bicyclists, animals, or objects that are moving, protruding, located too far above or below the sensors, or too close or too far from the sensors. Park Assist is for guidance purposes only and is not intended to replace your own direct visual checks. It is not a substitute for careful driving.

Visual and Audio Feedback

When you shift to Reverse, the Park Assist view displays on the left side of the instrument panel, showing any objects that are in close proximity to the front and rear of Model S. This view closes when you shift into Drive unless objects are detected close to the front of the Model S, in which case the Park Assist view closes automatically when your driving speed exceeds 5 mph (8 km/h). When reversing, visual feedback also displays on the touchscreen, immediately below the camera view (see [Rear View Camera](#) on page 64). You can manually close the park assist view on the touchscreen by touching the X in the upper left corner.

When driving with the Camera app displayed on the touchscreen, you can switch to the Park Assist view when driving at speeds below 5 mph (8 km/h). Touch the button located in the upper left corner of the Camera app window. This is useful if you need assistance with parallel parking.

If chimes are turned on (see [Controlling Audible Feedback](#) on page 58), an audible beep sounds as you approach an object. You can temporarily mute the chime by pressing the scroll wheel on the left side of the steering wheel or by touching the mute button located on the in the bottom left corner of the Park Assist view.

Note: If Model S is equipped with software version 6.1 or newer, and you are driving with the camera app displayed on the touchscreen, you can switch to the Park Assist view by touching the icon in the upper left corner of



the camera app window. You must be driving at speeds below 5 mph (8 km/h).

Note: If a sensor is unable to provide feedback, the instrument panel displays an alert message.

 Caution: Keep sensors clean from dirt, debris, snow, and ice. Avoid using a high pressure power washer on the sensors and do not clean a sensor with a sharp or abrasive object that can scratch or damage its surface.

 Caution: Do not install accessories or stickers on or near the parking sensors.

- An object that is mounted to Model S is interfering with and/or obstructing the sensor (such as a bike rack or a bumper sticker).

Other Parking Aids

In addition to Park Assist, when shifted into Reverse gear, the backup camera displays a view of the area behind Model S (see [Rear View Camera](#) on page 64).

Controlling Audible Feedback

You can use Park Assist with or without audible feedback. To turn chimes on or off, touch Controls > Settings > Safety & Security > Park Assist Chimes.

You can also mute the chimes temporarily by pressing the scroll wheel on the left side of the steering wheel or by touching the mute button in the bottom left corner of the Park Assist view. The chimes are muted until you shift into a different gear or drive over 5 mph (8 km/h).

Limitations and False Warnings

The parking sensors may not function correctly in these situations:

- One or more of the parking sensors is damaged, dirty, or covered (such as mud, ice, or snow).
- Object is located below approximately 8 inches (20 cm) (such as a curb or low barrier).
- Weather conditions (heavy rain, snow, or fog) are interfering with sensor operation.
- Object is thin (such as a sign post).
- A sensor's operating range has been exceeded.
- Object is sound-absorbing or soft (such as powder snow).
- Object is sloped (such as a sloped embankment).
- Model S has been parked in, or being driven in, extremely hot or cold temperatures.
- The sensors are affected by other electrical equipment or devices that generate ultrasonic waves.
- Object is located too close to the bumper.
- A bumper is misaligned or damaged.



When Model S is stopped, Vehicle Hold continues to apply the brakes even after you remove your foot from the brake pedal. When driving up a hill or on a flat surface, brake as you normally would and when Model S is fully stopped, the brakes remain engaged when you release the pedal. When driving downhill, engage Vehicle Hold by applying the brakes firmly after coming to a complete stop. Whenever Vehicle Hold is actively applying the brakes, the instrument panel displays the Vehicle Hold indicator light.



This indicator displays on the instrument panel whenever Vehicle Hold is engaged.

To disengage Vehicle Hold, press the accelerator pedal or press and release the brake pedal. Shifting into Neutral also releases Vehicle Hold.

Note: After actively braking Model S for approximately 10 minutes, Model S shifts into Park and Vehicle Hold cancels. Model S also shifts into Park if it detects that the driver has left the vehicle.



Performance Dual Motor Vehicles Only

Launch Mode, available on performance dual motor vehicles only, provides optimum acceleration on surfaces with good traction.

⚠ Warning: Use Launch Mode only in appropriate locations where there is no cross traffic or pedestrians present. Launch Mode is designed for use on closed circuit driving courses. It is the driver's responsibility to ensure that driving style and acceleration do not endanger or inconvenience other road users.

To Activate Launch Mode

Before activating Launch Mode, it is recommended that the brakes are slightly warm by driving for a few minutes and using the brakes a few times.

1. Set the acceleration level to Insane or Ludicrous and enable Max Battery Power (see [Controls](#) on page 94).
2. With Model S shifted into Drive and at a complete stop with the steering wheel straight, fully press the brake pedal with your left foot.
3. While still pressing the brake with your left foot, fully press the accelerator pedal with your right foot, then release the accelerator pedal. The instrument panel displays a message indicating that Launch Mode is enabled.
4. Within eight seconds, fully press the accelerator pedal a second time to pre-load motor torque, then within four seconds, release the brake.

When you release the brake, Model S launches forward.

Note: Launch Mode is not available if Slip Start has been enabled (i.e. wheels can spin). See [Traction Control](#) on page 56.

Note: You can use Launch Mode immediately after enabling Max Battery Power. There is no need to wait until Max Battery Power is in its READY state.

Limitations

Launch Mode is available only if the ambient temperature is 37° F (3° C) or warmer.



Displaying Trip Information

Trip information displays on the touchscreen when you touch Controls > Trips. There are two trip meters available, A and B. To reset a particular trip meter, touch its associated RESET.

Note: You can also display range and trip information on the instrument panel (see [Using Left Steering Wheel Buttons](#) on page 37).



Driving Tips to Maximize Range

You can maximize your driving range using the same driving habits that you use to conserve fuel in a gasoline-powered vehicle. In addition to driving habits, energy consumption depends on environmental conditions (such as cold weather and hilly roads). To get the maximum mileage from a charge:

- Slow down your driving and avoid frequent and rapid acceleration.
- Instead of using the brake pedal to slow down, modulate the accelerator pedal. Whenever Model S is moving and you are not pressing the accelerator pedal, regenerative braking slows down Model S and feeds surplus energy back to the Battery (see [Regenerative Braking](#) on page 55).
- Keep tires at the recommended inflation pressures (see [Tire Care and Maintenance](#) on page 135).
- Lighten your load by removing any unnecessary cargo.
- Limit the use of resources such as heating and air conditioning. Using seat heaters to keep warm is more efficient than heating the cabin. To automatically limit the amount of power that the climate control system uses to maintain the temperature of the Battery and the cabin area, touch Controls > Driving > Range Mode > ON.

The power meter on the instrument panel and the Energy app (described next) provide feedback on energy usage. With this feedback, you will soon become familiar with how driving habits and environmental conditions impact how much energy Model S is using.

Energy App

Use the energy app to view real-time and projected energy usage. Choose from two types of charts:

- Consumption Chart - display how much energy Model S has consumed over the past 5, 15 or 30 miles (10, 25 or 50 km).

- Trip Chart - If your Model S is equipped with the navigation option, you can monitor the amount of energy being used while navigating to a destination. You can track actual usage against the initial prediction. The green line represents the actual usage whereas the gray line represents predicted usage. To change the zoom level, touch the zoom icon located in the top right corner of the chart.

Note: The Trip Chart displays energy usage only if you are currently navigating to a destination.

Saving Energy

Model S has an energy-saving feature that reduces the amount of energy being consumed when Model S is not in use. Touch Controls > Displays > Energy Saving and choose from the following options:

- OFF. Model S shifts to the energy-saving mode at night (10 pm to 5 am).
- ON. Significantly less energy is consumed whenever Model S is not in use. The start-up time of the instrument panel and Bluetooth could be slower.
- Always Connected. Preserves cell connectivity when energy saving is active. This allows the mobile app to connect to Model S more quickly, and provides immediate 3G internet access when entering the car. Slightly more energy is consumed.

Range Assurance

Model S protects you against running out of energy. Model S continuously monitors its energy level and proximity to known charging locations.

Touch the range assurance icon, located in the top right corner of the map/navigation window, to control what charging stations display on the map:



The map displays superchargers only.



The map displays all visited chargers, Chademo chargers, and destination chargers. In situations where a charging location may not be reachable based on your currently available driving range, its associated icon on the map displays as semi-transparent.

When you are at risk of driving beyond the range of known charging locations, a popup message displays on the touchscreen giving you the opportunity to display a list of charging locations that are within range. The list includes superchargers, destination chargers, and locations where you have previously charged. When you select a charging location from the list, Model S provides navigation instructions and the turn-by-turn direction list displays the predicted amount of energy that will remain when you arrive at the charging destination.

In addition to the popup message that displays when you are at risk of driving beyond the range of known charging locations, a warning symbol displays on the range assurance icon:



Touch to display a search list of charging locations that are estimated to be within your driving range. Then touch a location in the search list to navigate to it.



Based on the amount of energy remaining in your Model S, there are no known charging locations within your driving range.



Camera Location

Model S is equipped with a rear view camera located above the rear license plate.

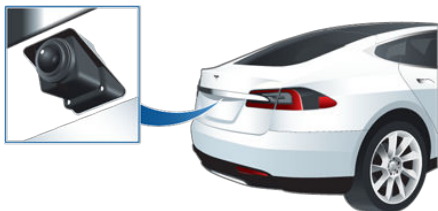

Whenever you shift into Reverse, the touchscreen displays the view from the camera. Guide lines show your driving path based on the position of the steering wheel. These guide lines adjust appropriately as you move the steering wheel.

Note: Visual feedback from the parking sensors displays below the camera image (see [Park Assist](#) on page 57).

Note: Depending on date of manufacture and options selected at time of purchase, some Model S vehicles are not equipped with parking sensors.

⚠ Warning: Never depend on the rear view camera to inform you if the area behind you is free of objects and/or people when reversing. The camera may not detect objects or barriers that can potentially cause damage or injury. In addition, several external factors can reduce the performance of the camera, including a dirty or obstructed lens. Therefore, depending on the rear view camera to determine if Model S is approaching an obstruction can result in damage to the vehicle and/or objects, and can potentially cause serious injury. Always inspect the area with your own eyes. When reversing, perform shoulder checks and use all mirrors. Use the camera for guidance purposes only. It is not intended to replace your own direct visual checks and is not a substitute for careful driving.

Cleaning the Camera

To ensure a clear picture, keep the camera lens clean, and free of obstructions. Remove any buildup of dirt by occasionally wiping the camera lens with a soft damp cloth.

⚠ Caution: Do not use chemical-based or abrasive cleaners. Doing so can damage the surface of the camera lens.



Driver Assistance Components

A Model S equipped with Driver Assistance features includes the following components that actively monitor the surrounding roadway:

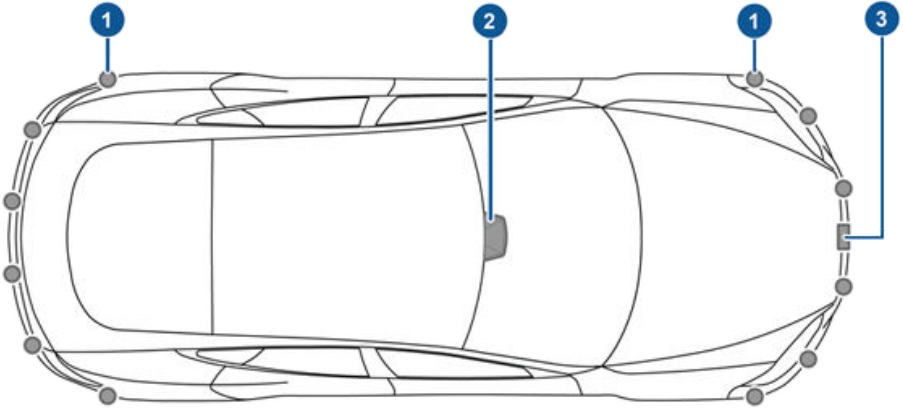

1. Ultrasonic sensors are located near the front and rear bumpers.
2. A forward looking camera is mounted on the windshield under the rear view mirror.
3. Radar is mounted in the front grill.

Driver Assistance vehicles also include high precision electrically-assisted braking and steering systems.

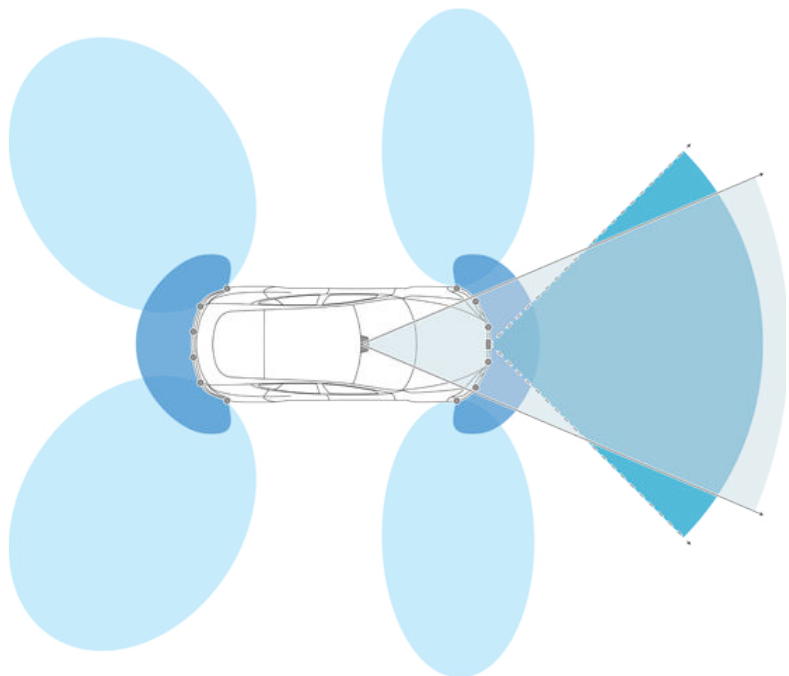

Note: The exact detection zone may vary depending on environmental conditions.



Driver Assistance Features

These safety features are available on all Model S vehicles equipped with Driver Assistance components:

- Lane Assist (see [Lane Assist](#) on page 83).
- Collision Avoidance Assist (see [Collision Avoidance Assist](#) on page 85).
- Speed Assist (see [Speed Assist](#) on page 88).

These convenience features, designed to reduce driver workload, are available only if Model S is equipped with the optional Autopilot Tech Package:

- Traffic-Aware Cruise Control (see [Traffic-Aware Cruise Control](#) on page 68).
- Autosteer (see [Autosteer](#) on page 74).
- Auto Lane Change (see [Auto Lane Change](#) on page 77).
- Autopark (see [Autopark](#) on page 79).
- Auto High Beam (see [High Beam Headlights](#) on page 51).

You can enable/disable driver assistance features and in some cases, control how they work. To access settings for Driver Assistance features, touch Controls > Settings > Driver Assistance.

Limitations

Many factors can impact the performance of Driver Assistance components, causing them to be unable to function as intended. These include (but are not limited to):

- Poor visibility (due to heavy rain, snow, fog, etc.).
- Bright light (oncoming headlights or direct sunlight).
- Damage or obstructions caused by mud, ice, snow, etc.
- Interference or obstruction by object(s) mounted onto Model S (such as a bike rack or a sticker).
- Narrow or winding roads.
- A damaged or misaligned bumper.
- Interference from other equipment that generates ultrasonic waves.
- Extremely hot or cold temperatures.

⚠ Warning: The list above does not represent an exhaustive list of situations that may interfere with proper operation of Driver Assistance components. Never depend on these components to keep

you safe. It is the driver's responsibility to stay alert, drive safely, and be in control of the vehicle at all times.

⚠ Caution: If a windshield replacement is needed on a Model S equipped with the forward looking camera, you must take your vehicle to Tesla Service. This will ensure appropriate handling and mounting of the camera. Failure to do so can cause one or more Driver Assistance features to malfunction.

Cleaning Driver Assistance Components

To ensure the various Driver Assistance components can provide information that is as accurate as possible, keep them clean and free of obstructions. Occasionally remove any buildup of dirt by wiping with a soft cloth dampened with warm water.

⚠ Caution: Do not use chemical-based or abrasive cleaners. Doing so can damage surfaces.

⚠ Caution: Avoid using a high-pressure power washer.

⚠ Caution: Do not clean an ultrasonic sensor with a sharp or abrasive object that can scratch or damage its surface.



If Model S is equipped with Driver Assistance components (see [About Driver Assistance](#) on page 65) and you have purchased the optional Autopilot Tech Package, the forward looking camera and the radar sensor are designed to determine when there is a vehicle in front of you in the same lane. If the area in front of Model S is clear, Traffic-Aware Cruise Control maintains a set driving speed. When a vehicle is detected, Traffic-Aware Cruise Control is designed to slow down Model S as needed to maintain a selected time-based distance from the vehicle in front, up to the set speed. Traffic-Aware Cruise Control does not eliminate the need to watch the road in front of you and to apply the brakes when needed.

Traffic-Aware Cruise Control is primarily intended for driving on dry, straight roads, such as highways and freeways. It should not be used on city streets.

Warning: Traffic-Aware Cruise Control is designed for your driving comfort and convenience and is not a collision warning or avoidance system. It is your responsibility to stay alert, drive safely, and be in control of the vehicle at all times. Never depend on Traffic-Aware Cruise Control to adequately slow down Model S. Always watch the road in front of you and be prepared to take corrective action at all times. Failure to do so can result in serious injury or death.

Warning: Do not use Traffic-Aware Cruise Control on city streets or on roads where traffic conditions are constantly changing and where bicycles and pedestrians are present.

Warning: Do not use Traffic-Aware Cruise Control on winding roads with sharp curves, on icy or slippery road surfaces, or when weather conditions (such as heavy rain, snow, fog, etc) make it inappropriate to drive at a consistent speed. Traffic-Aware Cruise Control does not adapt driving speed based on road and driving conditions.

Operating Traffic-Aware Cruise Control



The instrument panel displays a gray speedometer icon on the left side of the driving speed to indicate that Traffic-Aware Cruise Control is available but the cruising speed has not been set. Unless a vehicle is detected ahead of you, you must be driving at least 18 mph (30 km/h) to use Traffic-Aware Cruise Control. If a vehicle is detected ahead of you, you can use Traffic-Aware Cruise Control at any speed, even when stationary.

When driving at your desired speed, set the cruising speed by moving the cruise control lever up or down (or pulling it briefly toward you), then releasing.

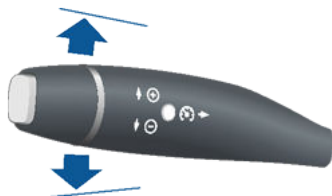

The speedometer icon on the instrument panel turns blue and displays the set speed to indicate that Traffic-Aware Cruise Control is actively maintaining the set speed.

You can now release the accelerator pedal and allow Traffic-Aware Cruise Control to maintain your set speed. When no vehicle is detected ahead, Traffic-Aware Cruise Control maintains the set speed. If a vehicle is detected, Traffic-Aware Cruise Control maintains your chosen following distance, up to the set speed, accelerating and decelerating Model S as needed. When the vehicle you are following is no longer detected, Traffic-Aware Cruise Control accelerates back to the set speed. Traffic-Aware Cruise Control also adjusts the speed as appropriate when entering and exiting curves.



You can accelerate at any time when driving at a set speed using Traffic-Aware Cruise Control. But when you release the accelerator, Model S returns to the set speed.

When following a vehicle, Traffic-Aware Cruise Control remains active at low speeds, even if Model S comes to a standstill while following a vehicle. When traffic is moving again, Traffic-Aware Cruise Control resumes operating at your currently set speed. However, if a pedestrian or object is detected in front of Model S, Traffic-Aware Cruise Control goes into a HOLD state and the instrument panel displays a message indicating that you need to resume cruise control. To resume, press the accelerator pedal or pull the cruise control lever toward you (see [Canceling and Resuming](#) on page 72).

In right hand traffic, engaging the right turn signal when driving in the right-most lane within 164 feet (50 meters) of an exit (on a restricted access road only, such as a highway or freeway), causes Traffic-Aware Cruise Control to assume you are exiting. As a result, Traffic-Aware Cruise Control begins to slow down the vehicle. Likewise in left hand traffic, when engaging the left turn signal when driving in the left-most lane within 164 feet (50 meters) of an exit. The onboard GPS (Global Positioning System) determines if you are driving in a region with right or left hand traffic. In situations where GPS data is unavailable (for example, inadequate signal), engaging the turn signal near an exit does not cause Traffic-Aware Cruise Control to slow down the vehicle.

Note: If you double-pull the cruise control lever, Autosteer activates and the set speed changes to your current driving speed. If you pull and hold the lever momentarily, your set cruising speed is adjusted to either your current driving speed, or the speed limit that is in effect, whichever is greater (see [Cruising at the Speed Limit](#) on page 70).

Note: When Traffic-Aware Cruise Control is actively slowing down Model S to maintain the selected distance from the vehicle ahead, the brake lights turn on to alert other road users that you are slowing down. You may also notice slight movement of the brake pedal.

⚠ Warning: Due to limitations inherent in the onboard GPS, you may experience situations in which Traffic-Aware Cruise Control slows down the vehicle, especially near highway exits where a curve is detected.

⚠ Warning: Traffic-Aware Cruise Control can not detect all objects and may not brake/decelerate for stationary vehicles, especially in situations when you are driving over 50 mph (80 km/h) and a vehicle you are following moves out of your driving path and a stationary vehicle or object, bicycle, or pedestrian is in front of you instead. Always pay attention to the road ahead and stay prepared to take immediate corrective action. Depending on Traffic-Aware Cruise Control to avoid a collision can result in serious injury or death. In addition, Traffic-Aware Cruise Control may react to vehicles or objects that either do not exist or are not in the lane of travel, causing Model S to slow down unnecessarily or inappropriately.

⚠ Warning: Traffic-Aware Cruise Control may be unable to provide adequate speed control because of limited braking capability and hills. It can also misjudge the distance from a vehicle ahead. Driving downhill can increase driving speed, causing Model S to exceed your set speed. Never depend on Traffic-Aware Cruise Control to slow down the vehicle enough to prevent a collision. Always keep your eyes on the road when driving and be prepared to take corrective action as needed. Depending on Traffic-Aware Cruise Control to slow the vehicle down enough to prevent a collision can result in serious injury or death.

⚠ Warning: Traffic-Aware Cruise Control may occasionally brake Model S when not required or you are not expecting it. This can be caused by closely following a vehicle ahead, detecting vehicles or objects in adjacent lanes (especially on curves), etc.

Adjust your following distance

To adjust the distance you want to maintain between Model S and a vehicle traveling ahead of you, rotate the cruise control lever to choose a setting from 1 (the closest following distance) to 7 (the longest following distance). Each setting corresponds to a time-based distance that represents how long it takes for Model S, from its current location, to reach the location of the rear bumper of the vehicle ahead.



Note: A horizontal line displays on the instrument panel to represent your following distance from a vehicle ahead (see [Instrument Panel - Driving](#) on page 46).

As you rotate the cruise control lever, the instrument panel displays the current setting. Release the lever when the desired setting is displayed.



Cruising at the Speed Limit

Traffic-Aware Cruise Control makes it easy to cruise at the speed limit. Once you've initially set a cruising speed, you can adjust the speed to cruise at the speed limit that is currently being determined by Speed Assist (see [Speed Assist](#) on page 88). To do so, pull the cruise control lever toward you and hold momentarily (about half a second). When you release, your cruising speed is set to the speed that is automatically or manually being determined by Speed Assist, taking into consideration any offset you have specified. If you are already driving faster than the speed limit when you pull and momentarily hold the lever, the set speed adjusts to your current driving speed.

Note: When you adjust the cruising speed based on the speed limit, the set speed does not change when the speed limit changes. You must pull and hold the cruise control lever again to cruise at the new speed limit. You can also manually adjust your cruising speed at any time (see [Changing the Set Speed](#) on page 70).

Note: If Speed Assist is unable to determine a speed limit, your set speed does not change when you pull the cruise control lever toward you and hold momentarily.

Warning: Do not rely on Speed Assist to determine an accurate or appropriate cruising speed. Always cruise at a safe speed based on road conditions.

Changing the Set Speed

To change the set speed while using Traffic-Aware Cruise Control, move the cruise control lever up (increase) or down (decrease) until your desired speed is reached.

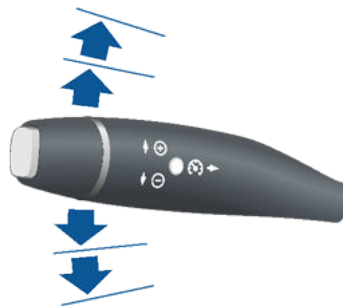

To increase/decrease speed by 1 mph (1 km/h), move the lever up or down to the first position and release. To increase/decrease speed to the closest 5 mph (5 km/h) increment, move the lever up/down to the second position and release. For example, if you are traveling at 57 mph and you move the lever up to the second position and release, the speed increases to 60 mph. You can also increase/decrease speed by holding the lever in the full up/down position and releasing when the desired speed displays below the cruise control icon.

To cruise at the speed limit that is currently being determined by Speed Assist (including any offsets that you have set), pull the cruise control lever toward you and hold momentarily (about half a second). See [Speed Assist](#) on page 88.

Note: It may take a few seconds for Model S to reach the new cruising speed.

Note: The maximum set speed is 90 mph (150 km/h).



Overtake Acceleration

When following a vehicle with Traffic-Aware Cruise Control active, engaging the turn signal to indicate a move into the passing lane briefly accelerates Model S towards the vehicle ahead. By momentarily holding the turn signal lever up or down (depending on the region you are driving in), you can quickly accelerate up to your set speed without having to press the accelerator pedal. The turn signal accelerates Model S only when the following conditions are met:

- Traffic-Aware Cruise Control is operating and detecting a vehicle in front.
- No obstacles or vehicles are detected in the target lane.
- Model S is traveling below the set speed, but over 45 mph (72 km/h).
- The turn signal indicates a move into the passing lane.

Overtake Acceleration is intended as an aid when passing a vehicle ahead of you. When the turn signal is engaged, Traffic-Aware Cruise Control continues to maintain distance from the vehicle ahead, but allows you to drive slightly closer than your selected distance.

Note: Model S uses its onboard GPS (Global Positioning System) to determine if you are driving in a region with right or left hand traffic. This enables the appropriate turn signal to provide overtake acceleration. When driving in right hand traffic, only the left turn signal indicates a move into the passing lane. In left hand traffic, only the right turn signal (moving the turn signal lever up) indicates passing. In situations where GPS data is unavailable (for example, inadequate signal), the turn signal does not activate Overtake Acceleration.

Acceleration cancels when:

- You reach your set cruising speed.
- Changing lanes takes too long.
- Model S gets too close to the vehicle ahead.

OR

- You disengage the turn signal.

Note: Your chosen setting is retained until you manually change it.

Note: Overtake Acceleration occurs when you either fully engage the turn signal, or you hold the turn signal in the momentary position (partially engaged). When you release or disengage the turn signal, Model S stops accelerating (in the same way as when you

release the accelerator pedal) and resumes the set speed.

 Warning: Overtake Acceleration can cancel for many unforeseen reasons in addition to those listed above (for example, lack of GPS data). Stay alert and never depend on Overtake Acceleration to increase your driving speed.

 Warning: Overtake Acceleration increases your driving speed whenever the appropriate turn signal is engaged, and accelerates Model S closer to the vehicle ahead. Although Traffic-Aware Cruise Control continues to maintain distance from the vehicle ahead, it is important to be aware that your selected following distance is reduced when Overtake Acceleration is active, particularly in cases where it may not be your intention to overtake the vehicle you are following.



Canceling and Resuming

To manually cancel Traffic-Aware Cruise Control, briefly push the cruise control lever away from you or press the brake pedal. The speedometer icon on the instrument panel turns gray to indicate that cruise control is not actively controlling your speed.



To resume cruising at the previously set speed, briefly pull the cruise control lever toward you.



Note: Depending on date of manufacture, some Model S vehicles have a button on the end of the cruise control lever. Pressing this button when cruise control is active cancels cruise control.

Note: When Traffic-Aware Cruise Control cancels, Model S does not coast. Instead, regenerative braking slows down Model S in the same way as when you move your foot off the accelerator when driving without cruise control (see [Regenerative Braking](#) on page 55).

Warning: Traffic-Aware Cruise Control cancels, or may not be available, in the following situations:

- You press the brake pedal.
- Your driving speed drops below 18 mph (30 km/h) in situations when Model S does not detect a vehicle ahead within the specified distance.
- Your driving speed exceeds the maximum cruising speed of 90 mph (150 km/h).
- You shift Model S out of Drive.
- The driver's seat belt is unbuckled.
- A door is opened.

- The view from the radar sensor or camera is obstructed. This could be caused by dirt, mud, ice, snow, fog, etc.
- The traction control setting is manually disabled or is repeatedly engaging to prevent wheels from slipping.
- The wheels are spinning while at a standstill.
- The cruise control system is failing.
- The cruise control system requires service.

When Traffic-Aware Cruise Control is unavailable or cancels, Model S no longer drives consistently at a set speed and no longer maintains a specified distance from the vehicle ahead.

Warning: Traffic-Aware Cruise Control can cancel unexpectedly at any time for unforeseen reasons. Always watch the road in front of you and stay prepared to take appropriate action. It is the driver's responsibility to be in control of Model S at all times.

Summary of Cruise Indicators



Traffic-Aware Cruise Control is available but is not actively controlling your speed until you set the cruising speed. Accelerate until you reach a desired cruising speed, then briefly tap the cruise control lever up or down (or pull briefly toward you).



Traffic-Aware Cruise Control is operating and is maintaining the set speed because it is not actively tracking a vehicle in front. In situations where Traffic-Aware Cruise Control is actively tracking a vehicle, the vehicle in front is outlined in white and Model S will decelerate/accelerate as needed to maintain your chosen following distance.



Model S has fully stopped behind a vehicle it was following but a pedestrian or object was detected in front of Model S, causing Traffic-Aware Cruise Control to be in a HOLD state. Tap the accelerator pedal to resume cruising at the set speed.



Limitations

Traffic-Aware Cruise Control is particularly unlikely to operate as intended in the following types of situations:

- The road has sharp curves.
- Visibility is poor (due to heavy rain, snow, fog, etc.).
- Bright light (oncoming headlights or direct sunlight) is interfering with the camera's view.
- The radar sensor in the center of the front grill is obstructed (dirty, covered, etc.).
- The windshield area in the camera's field of view is obstructed (fogged over, dirty, covered by a sticker, etc.).



Note: Autosteer is a BETA feature in Release 7.1.

If Model S is equipped with Driver Assistance components (see [About Driver Assistance](#) on page 65), and you have purchased the optional Autopilot Tech Package, you can use Autosteer to manage steering and speed under certain circumstances. Autosteer builds upon Traffic-Aware Cruise Control, intelligently keeping Model S in its driving lane when cruising at a set speed. Using the forward looking camera, the radar sensor, and the ultrasonic sensors, Autosteer detects lane markings and the presence of vehicles and objects, steering Model S based on the lane markings and the vehicle directly in front of you.

Warning: Autosteer is a hands-on feature. You must keep your hands on the steering wheel at all times.

Warning: Autosteer is intended for use only on highways and limited-access roads with a fully attentive driver. When using Autosteer, hold the steering wheel and be mindful of road conditions and surrounding traffic. Do not use Autosteer on city streets or in areas where bicyclists or pedestrians may be present. Never depend on Autosteer to determine an appropriate driving path. Always be prepared to take immediate action. Failure to follow these instructions could cause serious property damage, injury or death.

Operating Autosteer

Before you can operate Autosteer, you must enable it by touching Controls > Settings > Driver Assistance > Autosteer > Enable.

To indicate that Autosteer is available (but not actively steering Model S), the instrument panel displays a gray Autosteer icon on the right side of the driving speed as shown here:



To initiate Autosteer, pull the cruise control lever toward you twice in quick succession. Autosteer briefly displays a message on the instrument panel reminding you to pay attention to the road and be ready to take over at any time. To indicate that Autosteer is now actively steering Model S, the instrument panel displays the Autosteer icon in blue. When Autosteer is able to detect lane markings, it also displays the driving lane in blue:

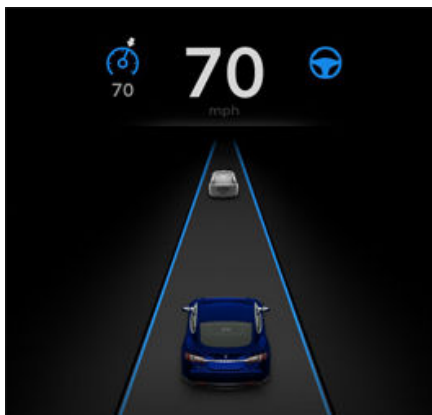

Note: To initiate Autosteer, you must be driving at least 18 mph (30 km/h) on a roadway with visible lane markings. If a vehicle is detected ahead of you, you can initiate Autosteer at any speed, even when stationary.

Note: In most cases, Autosteer attempts to center Model S in the driving lane. However, if the sensors detect the presence an obstacle (such as a vehicle or guard rail), Autosteer may steer Model S in a driving path that is offset from the center of the lane.

Note: In situations where you attempt to engage Autosteer but you are not driving within the required driving speed for Autosteer to operate, or Autosteer is not receiving adequate data from the camera or sensors, a message displays on the instrument panel indicating that Autosteer is temporarily unavailable.



Restricted Roads

Autosteer is intended for use on freeways and highways where access is limited by entry and exit ramps. When using Autosteer on residential roads, a road without a center divider, or a road where access is not limited, Autosteer limits the driving speed. The maximum driving speed is calculated based on the detected speed limit plus 5 mph (10 km/h). In situations where the speed limit can not be detected, speed is limited to 45 mph (70 km/h). When Autosteer is engaged on a restricted road, it reduces the speed to be within these limits, even if the set cruising speed is higher. The instrument panel displays a message indicating that you are driving on a restricted road. You can manually accelerate to exceed the limited speed, but when you release the accelerator pedal, Autosteer slows Model S to the limited speed. When you leave the restricted road, or disengage Autosteer by using the steering wheel, Model S resumes cruising at the set speed.

Hold Steering Wheel

Autosteer uses data from the camera, sensors, and GPS system to determine where to drive. It also requires you to hold the steering wheel. When entering a curve or driving at a high speed, if Autosteer does not detect your hands on the steering wheel, it displays the following message on the instrument panel and eventually sounds a chime:



When you see this message, you may need to tighten your grip on the steering wheel. When your hands are detected, Autosteer resumes normal operation.

Note: Be careful not to apply any steering. Doing so cancels Autosteer.

If Autosteer does not detect your hands on the steering wheel, the Hold Steering Wheel request escalates by sounding two additional chimes. The chimes increase in frequency until Autosteer detects your hands. If no action is taken, Autosteer begins to decelerate Model S and displays the following message on the instrument panel:

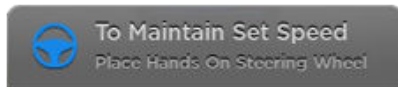

Autosteer will eventually decelerate Model S to a full stop and then turn on the hazard warning flashers.

Take Over Immediately

In situations where Autosteer is unable to steer Model S, Autosteer sounds a warning chime and displays the following message on the instrument panel:



When you see this message, TAKE OVER STEERING IMMEDIATELY.

Canceling Autosteer

Autosteer cancels when:

- You start steering manually.
- You press the brake pedal.
- You push the cruise control lever away from you.
- You unbuckle the driver's seat belt.
- The maximum speed that Autosteer supports (90 mph/150 km/h) is exceeded.
- You shift out of the Drive gear.
- An Automatic Emergency Braking event occurs (see [Collision Avoidance Assist](#) on page 85).

When Autosteer cancels, the Autosteer icon is gray to indicate that Autosteer is no longer active.

Note: If Autosteer cancels because you started steering manually, Traffic-Aware Cruise Control remains active. Disengage Traffic-Aware Cruise Control as you normally would, by pressing the brake or briefly pushing the cruise control lever away from you.

To disable Autosteer so it is no longer available, touch Controls > Settings > Driver Assistance > Autosteer > Cancel.

Limitations

Autosteer is particularly unlikely to operate as intended in the following situations:







- Autosteer is unable to accurately determine lane markings due to poor visibility (heavy rain, snow, fog, etc.), or an obstructed, covered, or damaged camera or sensor.
- When driving on hills.
- The road has sharp curves or is excessively rough.
- Bright light (such as direct sunlight) is interfering with the camera's view.
- The sensors are affected by other electrical equipment or devices that generate ultrasonic waves.

 **Warning:** Many unforeseen circumstances can impair the operation of Autosteer. Always keep this in mind and remember that as a result, Autosteer may not steer Model S appropriately. Always drive attentively and be prepared to take immediate action.



If Model S is equipped with Driver Assistance components (see [About Driver Assistance](#) on page 65), and you have purchased the optional Autopilot Tech Package, you can use Auto Lane Change to move Model S into an adjacent lane without touching the steering wheel (which would cancel Autosteer). When both Traffic-Aware Cruise Control and Autosteer are active, Auto Lane Change intelligently steers Model S into an adjacent driving lane. Using the forward looking camera, the radar sensor, and the ultrasonic sensors, Autosteer detects lane markings and the presence of other vehicles.

Auto Lane Change is designed for use on highways and main roads with visible lane markings and under relatively predictable circumstances in which minimal steering and driver intervention is needed.

-  **Warning:** It is the driver's responsibility to determine whether a lane change is safe and appropriate. Auto Lane Change can not detect oncoming traffic in the target lane, especially fast moving vehicles from the rear. Therefore, before initiating a lane change, always check blind spots, lane markings, and the surrounding roadway to confirm it is safe and appropriate to move into the target lane.
-  **Warning:** Never depend on Auto Lane Change to determine an appropriate driving path. Drive attentively by watching the road and traffic ahead of you and monitoring the instrument panel for warnings. Always be prepared to take immediate action.
-  **Warning:** Do not use Auto Lane Change on city streets or on roads where traffic conditions are constantly changing and where bicycles and pedestrians are present.
-  **Warning:** The performance of Auto Lane Change depends on the forward looking camera's ability to recognize lane markings.
-  **Warning:** Do not use Auto Lane Change on winding roads with sharp curves, on icy or slippery roads, or when weather conditions (such as heavy rain, snow, fog, etc.) may be obstructing the view from the camera or sensors.

Operating Auto Lane Change

Before you can operate Auto Lane Change, you must enable it by touching Controls > Settings > Driver Assistance > Auto Lane Change > On.

Note: Before you can turn on Auto Lane Change, you must turn on Autosteer (see [Autosteer](#) on page 74). Without Autosteer, Auto Lane Change can not operate.

Note: Your chosen setting is retained until you manually change it. It is also saved in your driver profile.

To change lanes using Auto Lane Change:

- Perform visual checks to make sure it is safe and appropriate to move into the target lane.
- Engage the turn signal.

Auto Lane Change moves Model S into the adjacent lane in the direction indicated by the turn signal, provided the following conditions are met:

- The Auto Lane Change setting is turned on.
- The turn signal is engaged.
- Autosteer is actively steering Model S.
- The ultrasonic sensors detect no vehicle or obstacles up to the center of the target lane.
- The camera's view is not obstructed.
- Lane Assist does not detect a vehicle in the blind spot (see [Lane Assist](#) on page 83).
- Midway through the lane change, Auto Lane Change can detect the outside lane marking of the target lane.
- Driving speed is at least 30 mph (45 km/h).

As the lane change is in progress, Overtake Acceleration is activated, allowing Model S to accelerate closer to a vehicle in front (see [Overtake Acceleration](#) on page 71). Midway through the lane change, Auto Lane Change must be able to detect the target lane's outside lane marking. If this lane marking can not be detected, both Auto Lane Change and Autosteer will cancel.

Note: Auto Lane Change moves Model S one lane at a time. Moving into an additional lane requires you to engage the turn signal a second time when the first lane change is complete.

-  **Warning:** If Auto Lane Change can not detect the outside of the target lane



midway through the lane change, both Auto Lane Change and Autosteer will cancel. The instrument panel displays a message instructing you to take over the steering wheel immediately.

When Auto Lane Change is active, it is important to monitor its performance by watching the driving path in front of you. Stay prepared to take over steering at any time. On the instrument panel, the lane you are crossing over displays as a dashed blue line and once in your new lane, the lane markings display as solid blue lines.

In situations where Auto Lane Change is unable to operate at optimal performance, or can not operate due to inadequate data, the instrument panel displays a series of warnings. Therefore, when using Auto Lane Change, always pay attention to the instrument panel and be prepared to manually steer Model S.

 **Warning:** When Auto Lane Change is actively steering Model S, the steering wheel moves accordingly. Any significant restriction of the steering wheel's movement can cancel Auto Lane Change.

- Visibility is poor (due to heavy rain, snow, fog, etc.) or weather conditions are interfering with sensor operation.
- Bright light (oncoming headlights or direct sunlight) is interfering with the camera's view.
- A sensor or the camera is damaged or obstructed (such as by mud, fog, ice, or snow).
- The sensors are affected by other electrical equipment or devices that generate ultrasonic waves.
- Model S is being driven very close to a vehicle in front of it, which is blocking the camera's view.

 **Warning:** Many unforeseen circumstances can impair the operation of Auto Lane Change. Always keep this in mind and remember that as a result, Auto Lane Change may not steer Model S appropriately. Always drive attentively and stay prepared to immediately take action at any time.

Canceling Auto Lane Change

Auto Lane Change cancels when you manually move the steering wheel, press the brake pedal, or disengage the turn indicator before Model S crosses the markers on the existing lane.

To disable Auto Lane Change so it is no longer available, touch Controls > Settings > Driver Assistance > Auto Lane Change > Off.

Limitations

Auto Lane Change is particularly unlikely to operate as intended in the following types of situations:

- Auto Lane Change is unable to accurately determine lane markings. For example, lane markings are excessively worn, have been adjusted due to road construction, are changing quickly (lanes branching off, crossing over, or merging), objects or landscape features are casting strong shadows on the lane markings, or the road surface contains pavement seams or other high-contrast lines.
- A side collision warning is active (see [Lane Assist](#) on page 83) when you engage the turn signal.
- The road has sharp curves.



If Model S is equipped with Driver Assistance components (see [About Driver Assistance](#) on page 65), and you have purchased the optional Autopilot Tech Package, Autopark is designed to:

- Park Model S in parallel and perpendicular parking spaces on public roads. Using data from the ultrasonic sensors, Autopark finds parking spaces and maneuvers Model S into the space. See [Parking on Public Roads](#) on page 79.
- Summon Model S. Autopark's new Summon feature allows you to move Model S in and out of a parking space from outside the vehicle on a private residential property. See [Using Summon](#) on page 80.

Note: Summon is a BETA feature in Release 7.1 (not available in Canada). Please use this feature with caution, staying prepared to take immediate action at any time.

- ⚠ Warning:** Autopark's performance depends on the ability of the ultrasonic sensors to determine the vehicle's proximity to curbs, objects, and other vehicles.

Parking on Public Roads

When driving, follow these steps to allow Autopark: to maneuver Model S into a parking space:

1. When driving below 15 mph (24 km/h), monitor the instrument panel to determine when Autopark has detected a potential parking space. When Autopark detects a parking space, the instrument panel displays a parking icon.



Note: The parking icon appears only if the vehicle's position and/or the circumstances of the surrounding area are such that Autopark can determine an appropriate driving path. If Autopark can not determine an appropriate path (for example, when driving on a narrow street where moving into the parking space causes the front of the vehicle to extend into the adjacent lane), you can either reposition the vehicle, find a different parking space, or park manually.

Note: If the Autopark icon does not appear at potential parking spaces when driving at the indicated speed, it is possible that Autopark is calibrating. Autopark requires a calibration process when Model S is new, or when tires are changed (see [Calibration](#) on page 80).

2. Check to determine if the detected parking space is appropriate and safe. If so, pull forward and stop approximately a car length ahead of the parking space (as you normally would when parallel parking or when backing into a perpendicular parking space).
3. Release the steering wheel, engage the Reverse gear and touch Start Autopark on the touchscreen.
4. When parking is complete, Autopark displays the Complete message.





In situations where Autopark can not operate due to inadequate sensor data, the instrument panels displays an alert message indicating that you must manually park Model S.

Note: If you press the brake when Autopark is actively parking Model S, the parking process pauses until you press the Resume button on the touchscreen.

Note: Autopark detects potential perpendicular parking spaces that are at least 9.5 feet (2.9 meters) wide with a vehicle parked on each side. Autopark detects parallel



parking spaces that are at least 20 feet (6 meters), but less than 49 feet (15 meters) long. Autopark does not operate on angled parking spaces.

-  **Warning:** Never depend on Autopark to find a parking space that is legal, suitable, and safe. Autopark may not always detect objects in the parking space. Always perform visual checks to confirm that a parking space is appropriate and safe.
-  **Warning:** When Autopark is actively steering Model S, the steering wheel moves in accordance with Autopark's adjustments. Do not interfere with the movement of the steering wheel. Doing so cancels Autopark.
-  **Warning:** During the parking sequence, continually check your surroundings. Be prepared to apply the brakes to avoid vehicles, pedestrians, or objects.
-  **Warning:** When Autopark is active, monitor the touchscreen and instrument panel to ensure that you are aware of the instructions that Autopark is providing.

Calibration

During a parking sequence, Autopark must maneuver Model S with a great deal of precision. Therefore, before it can be used, Autopark must complete a calibration process. Calibration can take anywhere from 30 minutes to several days, depending on driving behavior. When Autopark is calibrating, a note displays on the Driver Assistance settings screen indicating that calibration is in progress. When calibration is complete, this note no longer displays and Autopark is available for use.

Note: Autopark repeats the calibration process whenever tires are changed.

To Cancel Parking

Autopark cancels the parking sequence when you manually move the steering wheel, or when you change gears. Autopark also cancels parking when:

- The parking sequence exceeds the maximum of seven moves.
- The driver's seat belt is unbuckled.
- A door is opened.
- You press the accelerator pedal.
- You press the brake pedal twice in quick succession.
- An Automatic Emergency Braking event occurs (see [Collision Avoidance Assist](#) on page 85).

To Pause Parking

To pause Autopark, press the brake pedal once. Model S stops and remains stopped until you press Resume on the touchscreen.

Limitations

Autopark is particularly unlikely to operate as intended in the following types of situations:

- The road is sloped. Autopark is designed to operate on flat roads only.
 - Visibility is poor (due to heavy rain, snow, fog, etc.).
 - The curb is constructed of material other than stone, or the curb can not be detected.
 - One or more of the ultrasonic sensors is damaged, dirty, or obstructed (such as by mud, ice, or snow).
 - Weather conditions (heavy rain, snow, fog, or extremely hot or cold temperatures) are interfering with sensor operation.
 - The sensors are affected by other electrical equipment or devices that generate ultrasonic waves.
-  **Warning:** Many unforeseen circumstances can impair Autopark's ability to park Model S. Keep this in mind and remember that as a result, Autopark may not steer Model S appropriately. Pay attention when parking Model S and stay prepared to immediately take control.

Using Summon

Note: Summon is a BETA feature in Release 7.1 and must be used only on a private residential property while continually monitoring the vehicle. Summon is not available in Canada.



Autopark's Summon feature allows you to park and unpark Model S from outside the vehicle.

Note: Summon is designed and intended for use only on a private residential property. In order to assist in ensuring proper use, the onboard GPS attempts to determine the location and disables Summon if it determines that the parking location is not appropriate. However, in some cases, the GPS may be unable to determine precisely whether the location is private or public. Therefore, it is ultimately and always the driver's responsibility to ensure that Summon is not used in public parking locations.

- ⚠ Warning:** Model S may not detect certain obstacles, including those that are very narrow (i.e. bicycles), lower than the fascia, or hanging from a ceiling. In addition, many unforeseen circumstances can impair Autopark's ability to move into, or out of, a parking space and as a result, Autopark may not appropriately steer Model S. Therefore, you must continually monitor the vehicle's movement and surroundings and remain prepared to stop Model S at any time by pressing the top center button (Lock/Unlock All button) on the key.

Before Using Summon

Follow these steps to enable Summon and specify the parameters under which it works:

1. To enable Summon, touch Controls > Settings > Driver Assistance > Summon > ON.
2. Specify the distance that you want Summon to stop from an object by touching the arrows associated with the Summon Stop Distance setting. For example, you may want Summon to stop within just a few inches of the garage wall. The stop distance applies only to objects directly in front of (when moving forward) or behind (when reversing) Model S when moving into the parking space.
3. Check Allow Narrow Spaces if you want Summon to park Model S in a narrow space.

- ⚠ Warning:** Parking in a narrow space limits the ability of the sensors to accurately detect the location of obstacles, increasing the risk of damage to Model S and/or surrounding objects.

4. Check Use Auto HomeLink if you want Summon to activate HomeLink to open/close a programmed HomeLink device (such as a garage door) during the parking process. If enabled, the HomeLink device automatically opens and closes when Model S enters or exits.

Note: This checkbox automatically opens and closes the HomeLink device only when using Summon. To automate HomeLink in other situations (such as when driving), you must access the HomeLink device's main settings by touching Controls > Settings > HomeLink (see [HomeLink^{fi} Universal Transceiver](#) on page 122).

Using Summon To Park

1. If applicable, open your garage door (this can be automated with HomeLink, see [HomeLink^{fi} Universal Transceiver](#) on page 122).
2. Align Model S laterally with the parking space so Model S can move straight into the space in either Drive or Reverse. You must also position Model S within 39 feet (12 meters) of the parking space because this is the maximum distance the vehicle will move.

Note: Use Summon on flat driveways only.

3. With Model S in Park, stand within 10 feet (3 meters) of the vehicle and press and hold the top center button on the key (Lock/Unlock All button) until the hazard lights blink continuously.

Note: The hazard lights flash once, the vehicle powers on, then within approximately five seconds, the hazard lights flash continuously. Do not proceed to the next step until the hazard lights are flashing continuously. If, after ten seconds, the hazard lights are not flashing continuously, release the Lock/Unlock All button, move closer to the vehicle, and try again.

4. While the hazard lights are flashing continuously, single press the Front Trunk (Frunk) button on the key to move Model S forward into the parking space, or single press the Rear Trunk button to reverse Model S into the parking space.



Autopark shifts Model S into Drive or Reverse (based on which button you pressed) and drives into the parking space until the sensors have detected an obstacle, or Model S has moved the maximum distance of 39 feet (12 meters), at which point parking is considered completed and Autopark shifts Model S into Park.

Note: If you want Autopark to move Model S multiple times in the same direction, up to the maximum of 39 feet (12 meters), press and release the key's Lock/Unlock All button to stop the parking process, then re-initiate the parking process by holding this button until hazard lights flash continuously. Then press the same button on the key (Front Trunk for forward or Rear Trunk for reverse).

Note: Autopark can move Model S a short distance laterally to avoid an obstacle but in doing so, does not return to the vehicle to its driving path (i.e. Autopark does not attempt to move Model S around an obstacle).

Note: All vehicle controls (steering wheel, brakes, accelerator pedal, gear stalk, etc.) are disabled when Autopark is in the process of moving Model S in or out of a parking space. Interacting with any control cancels the parking process, stops Model S and engages the parking brake.

Using Summon To Unpark

To use summon to unpark, you must have used it to park Model S and the vehicle must have remained stationary since parked.

Follow the same steps, but move the vehicle in the opposite direction using the other button on the key. For example, if you pulled forward into the parking space by pressing the Front Trunk (Frunk) button, press the Rear Trunk button to reverse out of the parking space (and vice versa). Provided the environment has not changed since Summon parked Model S (i.e. no obstructions have been introduced), Model S follows a similar path when it exits the parking space. If obstacles are detected, Model S attempts to avoid the obstacles while staying as close as possible to its original path. When Model S reaches the location at which the original parking process began, the unparking is considered complete, Model S stops and Autopark shifts Model S into Park.

Stopping or Canceling Summon

You can stop Model S at any time while Summon is actively moving Model S in or out of a parking space by pressing the key's top center button (Lock/Unlock All button). Summon also cancels when:

- Model S detects an obstacle and can not move forward for more than two seconds.
- The maximum distance of approximately 39 feet (12 meters) is exceeded.
- A door handle is pressed or a door is opened.
- You interact with any vehicle control (steering wheel, brakes, accelerator pedal, gear stalk, etc.).
- You press the key's front or rear trunk button.

Limitations

Summon is unlikely to operate as intended in the following types of situations:

- The road is sloped. Autopark is designed to operate on flat roads only.
- One or more of the ultrasonic sensors is damaged, dirty, or obstructed (such as by mud, ice, or snow).
- Weather conditions (heavy rain, snow, fog, or extremely hot or cold temperatures) are interfering with sensor operation.
- The sensors are affected by other electrical equipment or devices that generate ultrasonic waves.



Warning: The list above does not represent an exhaustive list of situations that may interfere with proper operation of Autopark's Summon feature. It is the driver's responsibility to remain in control of Model S at all times. Pay close attention to the parking and unparking process and stay prepared to take immediate action.



If Model S is equipped with Driver Assistance components (see [About Driver Assistance](#) on page 65), the forward looking camera monitors the markers on the lane you are driving in, and the ultrasonic sensors monitor the blind spot for the presence of a vehicle. To help you stay in your driving lane and to avoid side collisions, Lane Assist provides two types of warnings:

- **Lane Departure Warning:** If a front wheel passes over a lane marking and the associated turn signal is off, you may feel a slight vibration in the steering wheel. These warnings are active only when Model S is traveling over approximately 30 mph (50 km/h).
- **Side Collision Warning:** When an object, such as a vehicle, is detected in your blind spot or traveling close to the side of Model S, Lane Assist displays fluid lines radiating from the image of Model S on the instrument panel. The location of the lines correspond to the location of the detected object. The color of the lines (white, yellow, orange or red) represents the object's proximity to Model S, with white being the furthest and red being very close and requiring immediate attention. When the lines are red, a chime will sound. These warnings are active only when Model S is traveling between 18 mph (30 km/h) and approximately 85 mph (140 km/h).



In addition to warnings described above, Lane Assist provides steering interventions if Model S drifts into (or close to) an adjacent lane in which an object, such as a vehicle, is detected. In these situations, Model S automatically steers to a safer position in its driving lane. This steering is applied only when Model S is traveling between 30 mph (50 km/h) and 85 mph (140 km/h) on major roadways with clearly visible lane markings. When corrective steering is applied, the instrument panel briefly displays a warning message.

Note: Corrective steering is not applied when Autosteer is active

- ⚠ Warning: Lane Assist is for guidance purposes only and is not intended to replace your own direct visual checks. Never depend on Lane Assist to inform you of unintentionally driving outside of the boundaries of the driving lane or informing you that an object or vehicle is in your blind spot. Several external factors can reduce the performance of Lane Assist. It is the driver's responsibility to stay alert, pay attention to the driving lane and always be aware of other road users. Failure to do so can result in serious injury or death.
- ⚠ Warning: Steering interventions are minimal and are not designed to move Model S out of its driving lane. Do not rely on steering interventions to avoid side collisions.
- ⚠ Warning: Lane Departure Warning is designed to detect lane markings and may not detect the edge of a road, especially if the road has no curb. It is the driver's responsibility to drive attentively and stay within the boundaries of the driving lane.
- ⚠ Warning: Before changing lanes, always visually check the lane you are moving into by using side mirrors and performing the appropriate shoulder checks. Several factors can affect the performance of the Lane Assist warnings, resulting in lack of, or false warnings (see "Limitations and Inaccuracies" below).



Controlling Lane Assist Warnings

To turn Lane Departure Warning on or off, touch Controls > Settings > Driver Assistance > Lane Departure Warning.

To turn Side Collision Warning on or off, touch Controls > Settings > Driver Assistance > Side Collision Warning.

Note: Your chosen settings are retained until you manually change them. They are also saved in your driver profile.

Limitations and Inaccuracies

Lane Assist can not always clearly detect lane markings and you may experience unnecessary or invalid lane departure warnings in these situations:

- Visibility is poor and lane markings are not clearly visible (due to heavy rain, snow, fog, etc.). The exact detection zone of the ultrasonic sensors vary depending on environmental conditions.
- Bright light (oncoming headlights or direct sunlight) is interfering with the camera's view.
- Model S is being driven very close to a vehicle in front of it which is blocking the camera's view.
- The windshield area in the camera's field of view is obstructed (fogged over, dirty, covered by a sticker, etc.).
- Lane markings are excessively worn, have been adjusted due to road construction or are changing quickly (for example, lanes branching off, crossing over, or merging).
- The road is narrow or winding.
- Objects or landscape features are casting strong shadows on lane markers.

Side Collision Warning may not provide warnings, or may apply inappropriate warnings, in these situations:

- One or more of the ultrasonic sensors is damaged, dirty, or obstructed (such as by mud, ice, or snow).
- Weather conditions (heavy rain, snow, fog, or extremely hot or cold temperatures) are interfering with sensor operation.
- The sensors are affected by other electrical equipment or devices that generate ultrasonic waves.
- An object that is mounted to Model S is interfering with and/or obstructing a sensor (such as a bike rack or a bumper sticker).

In addition, Model S may not steer away from an adjacent vehicle, or may unnecessarily apply steering, if:

- You are driving Model S on sharp corners or on a curve at a relatively high speed.
- You are drifting into another lane but an object (such as a vehicle) is not present.
- A vehicle in another lane cuts in front of you or drifts into your driving lane.
- Model S is traveling less than 18 mph (30 km/h) or over 85 mph (140 km/h).
- One or more of the ultrasonic sensors is damaged, dirty, or obstructed (such as by mud, ice, or snow).
- Weather conditions (heavy rain, snow, fog, or extremely hot or cold temperatures) are interfering with sensor operation.
- The sensors are affected by other electrical equipment or devices that generate ultrasonic waves.
- An object mounted to Model S (such as a bike rack or a bumper sticker) is interfering with or obstructing a sensor.
- Visibility is poor and lane markings are not clearly visible (due to heavy rain, snow, fog, etc.).
- Bright light (oncoming headlights or direct sunlight) is interfering with the camera's view.
- Lane markings are excessively worn, have been adjusted due to road construction or are changing quickly (for example, lanes branching off, crossing over, or merging).



Warning: The lists above do not represent an exhaustive list of situations that may interfere with the Lane Assist warnings. Lane Assist may fail to provide warnings for many other reasons. To avoid a collision, stay alert and always pay attention to the roadway when driving Model S so you can anticipate the need to take corrective action as early as possible.



Caution: If a fault occurs with the Lane Assist system, Model S displays an alert. Contact Tesla Service.



If Model S is equipped with Driver Assistance components (see [About Driver Assistance](#) on page 65), the following collision avoidance features are designed to increase the safety of you and your passengers:

- Forward Collision Warning provides visual and audible warnings in situations where there is a high risk of a frontal collision (see [Forward Collision Warning](#) on page 85).
- Automatic Emergency Braking automatically applies braking to reduce the impact of a frontal collision (see [Automatic Emergency Braking](#) on page 86).

⚠ Warning: Forward Collision Warning is for guidance purposes only and is not a substitute for attentive driving and sound judgment. Keep your eyes on the road when driving and never depend on Forward Collision Warning to warn you of a potential collision. Several factors can reduce or impair performance, causing either unnecessary, invalid, inaccurate, or missed warnings. Depending on Forward Collision Warning to warn you of a potential collision can result in serious injury or death.

⚠ Warning: Automatic Emergency Braking is not designed to prevent a collision. At best, it can minimize the impact of a frontal collision by attempting to reduce your driving speed. Depending on Automatic Emergency Braking to avoid a collision can result in serious injury or death.

Forward Collision Warning

The forward looking camera and the radar sensor monitor the area in front of Model S for the presence of an object such as a vehicle, bicycle or pedestrian. If a collision is considered likely unless you take immediate corrective action, Forward Collision Warning is designed to sound a chime and highlight the vehicle in front of you in red on the instrument panel:



Warnings cancel automatically when the risk of a collision has been reduced (for example, you have decelerated or stopped Model S, or a vehicle in front has moved out of your driving path).

If immediate action is not taken when Model S issues a Forward Collision Warning, a collision is considered imminent and Automatic Emergency Braking (if enabled) automatically applies the brakes (see [Automatic Emergency Braking](#) on page 86).

By default, Forward Collision Warning is turned on. To turn it off or adjust its sensitivity, touch Controls > Settings > Driver Assistance > Forward Collision Warning. Instead of the default warning level of Medium, you can turn the warning Off, or you can choose to be warned Late or Early.

Note: Your chosen setting for Forward Collision Warning is retained until you manually change it. It is also saved in your driver profile.

⚠ Warning: The cameras and sensors associated with Forward Collision Warning are designed to monitor an approximate area of up to 525 feet (160 meters) in your driving path. The area being monitored by Forward Collision Warning can be adversely affected by road and weather conditions. Use appropriate caution when driving.

⚠ Warning: Forward Collision Warning is designed only to provide visual and audible alerts. It does not attempt to apply the brakes or decelerate Model S. When seeing and/or hearing a warning, it is the driver's responsibility to take corrective action immediately.

⚠ Warning: Forward Collision Warning may provide a warning in situations where the likelihood of collision may not exist. Stay



alert and always pay attention to the area in front of Model S so you can anticipate whether any action is required.

- Warning: Forward Collision Warning does not operate when Model S is traveling less than 4 mph (7 km/h).
- Warning: Forward Collision Warning does not provide a warning when the driver is already applying the brake.

Automatic Emergency Braking

The forward looking camera and the radar sensor are designed to determine the distance from any object (vehicle, motorcycle, bicycle, or pedestrian) traveling in front of Model S. When a frontal collision is considered unavoidable, Automatic Emergency Braking is designed to automatically apply the brakes to reduce the severity of the impact.

When Automatic Emergency Braking applies the brakes, the instrument panel displays a visual warning and you'll hear a chime. You may also notice abrupt downward movement of the brake pedal. The brake lights turn on to alert other road users that you are slowing down.



When Automatic Emergency Braking has reduced the driving speed by 25 mph (40 km/h), the brakes are released. For example, if Automatic Emergency Braking applies braking when driving at 56 mph (90 km/h), it releases the brakes when the speed has been reduced to 31 mph (50 km/h).

Automatic Emergency Braking operates only when driving between 5 mph (8 km/h) and 85 mph (140 km/h).

Automatic Emergency Braking does not apply the brakes, or stops applying the brakes, in situations where you are taking action to avoid a potential collision. For example:

- You turn the steering wheel sharply.
- You press the accelerator pedal.
- You press and release the brake pedal.
- A vehicle, motorcycle, bicycle, or pedestrian, is no longer detected ahead.

Automatic Emergency Braking is always enabled when you start Model S. To disable it for your current drive, touch Controls > Settings > Driver Assistance > Automatic Emergency Braking > Disable.

- Warning: It is strongly recommended that you do not disable Automatic Emergency Braking. If you disable it, Model S does not automatically apply the brakes in situations where a collision is considered likely.
- Warning: Automatic Emergency Braking is designed to reduce the severity of an impact. It is not designed to avoid a collision.
- Warning: Several factors can affect the performance of Automatic Emergency Braking, causing either no braking or inappropriate or untimely braking. It is the driver's responsibility to drive safely and remain in control of the vehicle at all times. Never depend on Automatic Emergency Braking to avoid or reduce the impact of a collision.
- Warning: Automatic Emergency Braking is designed to reduce the impact of frontal collisions only and does not function when Model S is in reverse.
- Warning: Automatic Emergency Braking is not a substitute for maintaining a safe traveling distance between you and the vehicle in front of you.
- Warning: The brake pedal moves downward abruptly during automatic braking events. Always ensure that the brake pedal can move freely. Do not place material on top of the Tesla-supplied driver's floor mat (including an additional mat) and always ensure that the driver's floor mat is properly secured. Failure to do so can impede the ability of the brake pedal to move freely.

Note: For advance notice of an Automatic Emergency Braking event, turn on Forward Collision Warning (see [Forward Collision Warning](#) on page 85). When turned on, you hear a chime and see a collision warning in the center of the instrument panel if a collision is considered likely. Then, if you do not take immediate corrective action, a collision is considered imminent and Automatic Emergency Braking applies braking to reduce driving speed. If enabled, Automatic Emergency Braking applies braking when a collision is considered inevitable, even if Forward Collision Warning is turned off.



Limitations and Inaccuracies

Collision Avoidance features cannot always detect vehicles, bikes, or pedestrians, and you may experience unnecessary, inaccurate, invalid, or missed warnings for many reasons, particularly if:

- The road has sharp curves.
- Visibility is poor (due to heavy rain, snow, fog, etc.).
- Bright light (oncoming headlights or direct sunlight) is interfering with the camera's view.
- The radar sensor in the center of the front grill is obstructed (dirty, covered, etc.).
- The windshield area in the camera's field of view is obstructed (fogged over, dirty, covered by a sticker, etc.).

 **Warning:** The limitations described above do not represent an exhaustive list of situations that may interfere with proper operation of Collision Avoidance Assist features. These features may fail to provide their intended function for many other reasons. It is the driver's responsibility to avoid collisions by staying alert and paying attention to the area beside Model S so you can anticipate the need to take corrective action as early as possible.

 **Caution:** If a fault occurs with a Collision Avoidance Assist feature, Model S displays an alert. Contact Tesla Service.



How Speed Assist Works

If Model S is equipped with Autopilot components (see [About Driver Assistance](#) on page 65), the forward looking camera detects speed limit signs. The signs are then analyzed and compared against GPS data to determine the speed limit at your current driving location. For routes where no signs are present, speed limits are determined using GPS data (if available). Instead of determining the speed limit based on signs and GPS data, you can also manually enter an arbitrary speed limit.

When Speed Assist is turned on (described below), the instrument panel displays a speed limit sign. Warnings (described below) take effect when you exceed this limit.

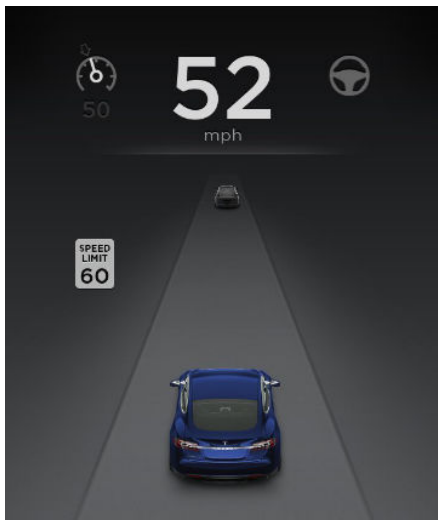

In situations where Speed Assist is unable to detect a speed (for example, speed limit signs and GPS data are not available at the current location), the instrument panel does not display a speed limit sign. If Speed Assist is uncertain that an acquired speed limit is accurate (for example, although a speed limit sign was initially detected, some time has passed before a subsequent sign has been detected), the speed limit sign is dimmed. In both cases, warnings do not take effect.

If you set the speed limit warning to Display (see [Controlling Speed Assist](#) on page 88), the speed limit sign on the instrumental panel increases in size whenever you exceed the speed limit.

If you set the speed limit warning to Chime (see [Controlling Speed Assist](#) on page 88) and exceed the speed limit, you also hear a warning chime.

Note: Speed limit warnings go away after 10 seconds, or when Model S slows down below the specified limit.

⚠ Warning: Do not rely on Speed Assist to determine the appropriate speed limit. Always drive at a safe speed based on traffic and road conditions.

Controlling Speed Assist

To turn Speed Assist on or off, and control how it works, touch Controls > Settings > Driver Assistance > Speed Limit Warning, then choose one of these options:

- Off. The speed limit is not displayed.
- Display. Speed limit signs display on the instrument panel and when you exceed the limit, the sign gets larger.
- Chime. In addition to the visual display, you'll hear a chime whenever you exceed the speed limit.

You can also specify how the speed limit is determined:

- Relative. The speed limit is determined automatically based on detected traffic signs and GPS data. If desired, you can set a speed limit offset (+ or -) if you want to be alerted only when you exceed the speed limit by a specified amount. For example, you would increase the offset to +10 mph (10 km/h) if you only want to be alerted when you exceed the speed limit by 10 mph (10 km/h).
- Absolute. Manually specify any speed limit between 20 and 140 mph (30 and 240 km/h).

Note: GPS data is not always accurate. The GPS can misjudge the road's location and provide the speed limit for a directly adjacent road that may have a different speed limit. For example, the GPS can assume Model S is on a freeway when it's actually on a nearby surface street, and vice versa.

Note: Your chosen setting is retained until you manually change it. It is also saved in your driver profile.



Limitations and Inaccuracies

Speed Assist may not be fully functional or may provide inaccurate information in these situations:

- Visibility is poor and speed limit signs are not clearly visible (due to heavy rain, snow, fog, etc.).
- Bright light (oncoming headlights or direct sunlight) is interfering with the camera's view.
- Model S is being driven very close to a vehicle in front of it which is blocking the camera's view.
- The windshield area in the camera's field of view is obstructed (fogged over, dirty, covered by a sticker, etc.).
- Speed limit signs are concealed by objects.
- The speed limits stored in the GPS database are incorrect or outdated.
- Model S is being driven in an area where GPS data is not available.
- Traffic signs do not conform to standard recognizable formats.
- A road or a speed limit has recently changed.

 **Warning:** The list above does not represent an exhaustive list of situations that may interfere with proper operation of Speed Assist. Speed Assist may fail to provide warnings for many other reasons.



The Big Picture

The main components of the touchscreen are shown here. To manually control the brightness and contrast, touch Controls > Displays. When set to Auto, the touchscreen changes between the Day (light background) and Night (dark background) setting depending on ambient lighting conditions.

Note: The following illustration is provided for demonstration purposes only. Depending on vehicle options, software version and market region, your touchscreen may appear slightly different.

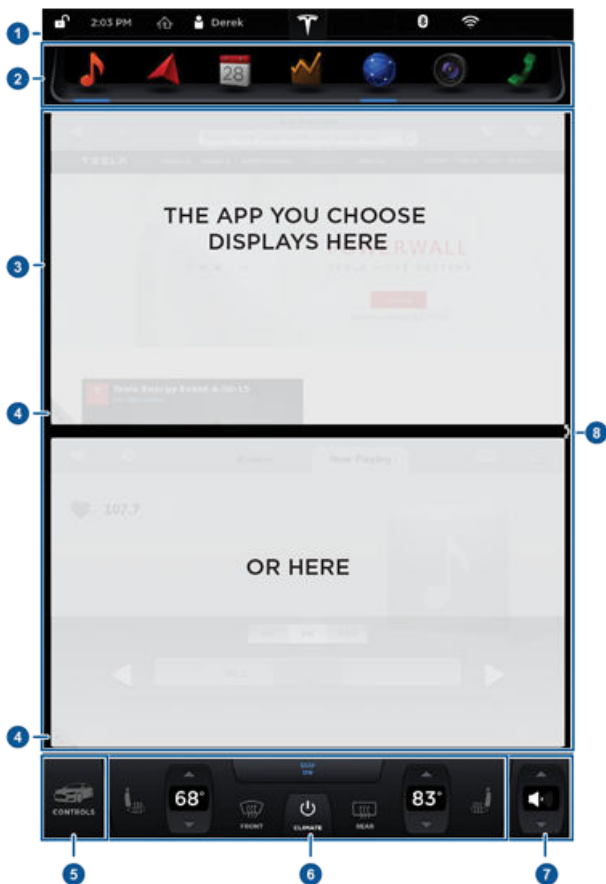



1. Status bar

The top line displays provides shortcuts to lock/unlock Model S, to access HomeLink and Driver Profiles, display vehicle information (the Tesla “T”), download software updates, display network strength and Bluetooth[®] status and Wi-Fi settings. If an alert icon (exclamation mark) is displayed, touch it to see warning messages that are in effect.

Note: The airbag status symbol displays only when Model S is powered on.

Note: You can also display the time and outside temperature on the instrument panel by choosing the Clock option using the left or right scroll wheel on the steering wheel (see [Steering Wheel](#) on page 37).

Note: Touch the lock icon to unlock/lock all doors. In situations where only the driver’s door is unlocked (for example, Door Unlock Mode is set to Driver), the lock icon displays as unlocked and touching it locks all doors. For more information on Door Unlock Mode, see [Doors](#) on page 4.



2. Apps

There are several ways to display an app in the main viewing area:

- Tap the app's icon to display it in the top viewing area. If the app is already displayed, a second tap displays it in full-screen view (only some apps have a full-screen mode).
- Drag the app's icon directly onto the top or bottom viewing area.
- Touch and hold the app's icon to display a popup that lets you choose whether to display the app in the top or bottom of the main viewing area.



Media. See [Media and Audio](#) on page 110.



Maps and Navigation (if equipped). See [Maps and Navigation](#) on page 116.



Calendar. See [Calendar](#) on page 119.



Energy. See [Getting Maximum Range](#) on page 62.



Web. Access the Internet using the web browser (if equipped).



Camera. Display the area behind Model S. This area also displays automatically whenever you shift into Reverse. See [Rear View Camera](#) on page 64.



Phone. See [Phone](#) on page 114.



3. Main viewing area

The main viewing area changes depending on the app you have chosen (in the example, the Nav and Media apps are displayed). For some apps (such as Nav and Web), you can zoom in and out using standard touchscreen finger gestures.

4. Maximize/minimize app

Touch the small rectangle to expand the associated app to fill the entire main viewing area (some apps are not expandable). Touch again to display two apps in half-screen view.

5. Controls

Touch to access all Model S controls and settings (doors, locks, lights, etc).

6. Climate controls (see [Climate Controls](#) on page 104).

7. Volume control

Touch the up and down arrows to increase or decrease the volume of the speakers. You can also adjust the volume using the scroll wheel on the left side of the steering wheel.

8. Reverse the position of the two currently displayed apps.

-  **Warning:** Paying attention to road and traffic conditions must always be the driver's highest priority. To ensure the safety of vehicle occupants as well as other road users, using the touchscreen should be done only when road and traffic conditions permit.



Controlling Features

Touch Controls on the bottom corner of the touchscreen to control and customize all main features of Model S.

Note: The following illustration is provided for demonstration purposes only. Depending on vehicle options, software version and market region, the options available on the Controls screen may be different.



1

2 Sunroof

3 Suspension

4 **Driving**

5 Cold Weather

6 Trips

7 Displays

8 E-Brake & Power Off

9

10

Controls Settings

STEERING MODE: COMFORT **STANDARD** SPORT

ACCELERATION: **SPORT** INSANE

CREEP: **OFF** ON

TRACTION CONTROL: SLIP START

Use to help free vehicle stuck in snow, sand, or mud

EFFICIENCY

REGENERATIVE BRAKING: **STANDARD** LOW

RANGE MODE : OFF **ON**

STANDARD increases range and extends brake life

DOORS & LOCKS

FRONT TRUNK

LOCK UNLOCK

CHARGE PORT TRUNK

LIGHTS

DOME **AMBIENT**

LEVEL

EXTERIOR LIGHTS: OFF **AUTO**



1. Close

Touch the circled X in the top left corner of a window to close it (or you can touch anywhere outside the window).

2. Sunroof

If Model S is equipped with a sunroof, touch to adjust its position (see [Sunroof](#) on page 15).

3. Suspension

If Model S is equipped with Smart Air Suspension, touch to manually raise or lower Model S, or to remove a previously saved auto-raising location (see [Smart Air Suspension](#) on page 108). Model S must be powered on and you must press the brake pedal before you can change suspension settings. Smart Air Suspension causes Model S to self-level, even when powered off. Therefore, when towing or lifting, you must disable self-leveling (see [Instructions for Transporters](#) on page 175 and [Jacking and Lifting](#) on page 158).



4. Driving

- Steering mode

Adjust the amount of effort required to turn the steering wheel. Sport feels more responsive whereas Comfort feels easier to drive and park (see [Steering Wheel](#) on page 37).

- Acceleration (Performance dual motors vehicles only)

Choose an acceleration level. Sport is the standard level of acceleration and allows you to maximize driving range. Choose Insane or Ludicrous (depending on the options available on your vehicle) to increase peak torque by approximately 60 percent.

If you choose Insane or Ludicrous, additional power is available immediately. However, to achieve the absolute maximum power (designed for short term use), touch Max Battery Power, which displays as blue text immediately below the acceleration setting. Max Battery Power heats the Battery to its ideal operating temperature to ensure access to 100% of available power. Heating the Battery can take over an hour, depending on environmental conditions and whether or not Model S is being driven. During this time, a message displays providing you with an approximate wait time. When the additional power is available, the message indicates that Max Battery Power is READY! When using Max Battery Power, Model S consumes more energy as it keeps the Battery within an optimal temperature range. To cancel Max Battery Power at any time, change the acceleration level to Sport (or touch the button in the Max Battery Mode popup). To prevent excess and potentially unnecessary energy consumption (for example, you leave the vehicle and forget to cancel Max Battery Power), Max Battery Power cancels automatically in three hours, regardless of whether you are still driving or have left the vehicle.

Note: To support Max Battery Power, the charge level must be 20% or higher. You cannot initiate Max Battery Power if the charge level is less than 20%. In addition, Max Battery Power immediately cancels if at any time during its use, the charge level drops below 20%.

Note: Max Battery Power strives to keep the pack within an optimal temperature range. In addition to heating the Battery, Max Battery Power also cools the battery when necessary (for example, during aggressive driving scenarios).

Note: Max Battery Power is designed to achieve maximum performance for short term acceleration and is not intended for daily driving. The tradeoff for the additional power boost is extra energy consumption and earlier power fade on long aggressive drives. The Insane or Ludicrous acceleration settings provide a significant increase in performance even without Max Battery Power. In fact, in normal driving situations, the additional power that can be achieved using Max Battery Power may not be noticeable.

Note: The Insane or Ludicrous acceleration setting is available only on newer Performance dual motor vehicles, depending on date of manufacture and options chosen at time of purchase.

- Creep

When on, Model S slowly moves forward when in Drive and backward in Reverse when you release the brake (similar to a conventional vehicle with an automatic transmission). You can adjust this setting only when Model S is in Park.

- Traction Control

To allow the wheels to spin on a standard single motor Model S, you can turn off traction control. On a dual motor Model S, you can enable Slip Start. If you turn off Traction Control (or enable Slip Start), a warning message displays on the instrument panel. Traction control turns off for the current drive only. On dual motor vehicles, traction control is automatically turned on again when the speed exceeds 40 mph (64 km/h). See [Traction Control](#) on page 56.

- Regenerative braking

When you release the accelerator when driving, regenerative braking slows Model S and feeds any surplus energy back to the Battery. If set to Low, Model S does not slow down as quickly, but you may experience less range (see [Regenerative Braking](#) on page 55).

Note: Regardless of the setting, the energy gained by regenerative braking is reduced if



5. Cold Weather

If Model S is equipped with the optional cold weather package, you can control all seat heaters as well as the heated wipers and steering wheel. Heaters that are turned on are displayed in red. To turn off all seat heaters, touch All Off. Note that you can also control the front driver and passenger seats using the main climate control panel located on the bottom of the touchscreen (see [Climate Controls](#) on page 104).

6. Trips

View and reset the trip meters that summarize how far you have driven (see [Trip Information](#) on page 61).

7. Displays

Manually control the brightness and the Day (light background) or Night (dark background) setting of the touchscreen and instrument panel. When set to Auto, the brightness changes automatically between day and night brightness based on ambient lighting conditions. When Auto-adjust is checked, the displays are further adjusted based on both the surroundings and by learning your preferences (i.e. it remembers the type of manual adjustments you make).

To disable the touchscreen momentarily for cleaning purposes, touch Clean Mode.

You can also put Model S into an energy saving mode so it consumes less energy when not in use (see [Getting Maximum Range](#) on page 62).

Note: The Displays settings can also be accessed from the Settings screen.

8. E-Brake & Power Off

You can manually:

- Apply and release the parking brake (see [Parking Brake](#) on page 55).
- Power off (see [Powering Off](#) on page 41).

9. Doors & Locks (see [Doors](#) on page 4)

10. Lights (see [Lights](#) on page 48)



Warning: Do not read the touchscreen while driving. Doing so increases the likelihood of a collision. Everything you need to know when driving is displayed on the instrument panel.



Customizing Your Vehicle

Touch the Settings tab on the Controls window to adjust Model S to suit your preferences.

Note: The following illustration is provided for demonstration purposes only. Depending on vehicle options, software version, and market region, the options available on the Settings screen may be different. For example, in many regions, the "Language & Units" tab is called "Units & Format."





1. Adjust settings associated with installed apps (applications). Settings associated with apps that are either unavailable on your Model S, or have no settings that you can adjust at this time, are grayed out.
2. Manage driver profiles (see [Driver Profiles](#) on page 35).
3. Units & Format

Adjust how Model S displays:

- Distance: Miles or km can be shown on the range display, speedometer, energy chart, trip meters, Google map searches and navigation routes.
- Time Format: 12 or 24 hour.
- Temperature: °C or °F.
- Energy & Charging: Display remaining energy and charging units as either a percentage of battery energy remaining, or as an estimate of the distance that you can drive. When you choose Distance, you can display mileage based on either:
 - Rated - based on EPA testing.
 - Ideal - assumes ideal driving conditions based on driving at a steady speed of 55 mph (89 km/h) on a flat road, and using no additional energy (seat heaters, air conditioning, etc).

Note: When anticipating when you need to charge, use range estimates as a general guideline only.



4. Vehicle

- Door Unlock Mode: Choose whether you want ALL doors, or just the DRIVER door, to unlock when you approach Model S carrying your key.
 - Walk-away Door Lock: If on, doors automatically lock when you walk away from Model S, carrying the key with you (see [Walk-away Locking](#) on page 7).
- Note: Depending on date of manufacture and options selected at time of purchase, some Model S vehicles are not equipped with the Walk Away Door Lock feature.
- Child-Protection Lock: If on, safety locks prevent the rear doors and the liftgate from being opened from inside Model S.
 - Auto-Present Handles: If on, door handles extend automatically whenever you approach Model S carrying a key, whether locked or unlocked (see [Doors](#) on page 4). Note that to preserve battery life, Model S is designed to temporarily disable the Auto-Present Handles feature when the key has been out of range for more than 48 hours, or if the key remains within range for five minutes after all doors have been closed.
 - Headlights After Exit: If on, headlights stay on for two minutes after you exit, or until you lock Model S (see [Headlights After Exit](#) on page 51).
 - Mirror Auto-Tilt: If on, exterior mirrors tilt downward when reversing (see [Mirrors](#) on page 40).

Note: Depending on date of manufacture and options selected at time of purchase, some Model S vehicles are not equipped with Mirror Auto-Tilt.

- Mirror Auto-Fold: If on, exterior mirrors fold when you lock Model S with the key or walk-away locking. They extend automatically when you return to Model S. You can also fold mirrors manually by touching the center mirror control button (see [Mirrors](#) on page 40).

Note: Depending on date of manufacture and options selected at time of purchase, some Model S vehicles are not equipped with Mirror Auto-Fold.

- Ionizer: If on, the air ionizer freshens the air in the cabin.
- Smart Preconditioning: If on, Model S predicts your driving schedule and automatically adjusts the temperature of the cabin based on your last set temperature and your driving schedule, making Model S comfortable and ready to drive. It may take some time for Model S to learn your driving habits and if you do not have a regular driving schedule, it will be unable to identify a pattern.

Note: To conserve energy in situations where Model S has a low charge level, smart preconditioning may not occur.

Note: Smart Preconditioning is available only if you save your home and work locations (see [Favorite Destinations](#) on page 118).

5. Safety & Security

Turn various safety and security features on and off:

- Active safety devices Model S is equipped with, such as Park Assist Chimes (see [Park Assist](#) on page 57).
- Alarm, and security options Model S is equipped with (see [Security Settings](#) on page 121).
- Remote access by Tesla's mobile applications (see [Mobile App](#) on page 126).

6. Displays

Manually control the brightness and the Day (light background) or Night (dark background) setting of the touchscreen and instrument panel. When set to Auto, the brightness changes automatically between day and night brightness based on ambient lighting conditions. When Auto-adjust is checked, the displays are further adjusted based on both the surroundings and by learning your preferences (i.e. it remembers the type of manual adjustments you make).

To disable the touchscreen momentarily for cleaning purposes, touch Clean Mode.

You can also put Model S into an energy saving mode so it consumes less energy when not in use (see [Getting Maximum Range](#) on page 62).

Note: The Displays settings can also be accessed from the Controls screen.

7. HomeLink

If the HomeLink feature is available in your region, use it to control RF-enabled garage doors, lights, or security systems (see [HomeLink^{fi} Universal Transceiver](#) on page 122).

8. Driver Assistance

If Model S is equipped with Driver Assistance components (see [About Driver Assistance](#) on page 65), you can control the features that provide a safer and more convenient driving experience:

- **Cruise Control:** Control whether you want to use Autosteer to intelligently keep Model S in its driving lane when cruising at a set speed (see [Autosteer](#) on page 74). Also control whether you want to use Auto Lane Change to move Model S into an adjacent lane without touching the steering wheel (see [Auto Lane Change](#) on page 77).
- **Lane Assist:** Control whether you want visual and audible warnings when an object, such as a vehicle, is detected in your blind spot or traveling close to the side of Model S and if you want the steering wheel to vibrate if a front wheel passes over a lane marking when the associated turn signal is off (see [Lane Assist](#) on page 83).
- **Speed Assist:** Control how speed limits are determined and how warnings are issued when you exceed the speed limit (see [Speed Assist](#) on page 88).
- **Collision Avoidance Assist:** Control if and when warnings display when a frontal collision is considered likely (see [Forward Collision Warning](#) on page 85) and disable the automatic emergency braking that occurs to minimize the impact of a collision (see [Automatic Emergency Braking](#) on page 86).

9. Service & Reset

Turn various service-related features on and off:

- **Service Mode:** If on, moves wiper blades to the service position to make them easier to access when replacing them. Model S must be in Park (see [Wiper Blades and Washer Jets](#) on page 147).
- **Tire Pressure Monitor:** Touch Reset Sensors to reset the TPMS sensors after replacing a wheel (see [Resetting the TPMS Sensors](#) on page 139).
- **Tow Mode:** Activate Tow Mode to keep Model S in Neutral (see [Keeping Your Vehicle in Neutral \(Tow Mode\)](#) on page 42).
- **Factory Reset:** Touch Erase & Reset to erase all personal data (saved addresses, music favorites, etc.) and restore all customized settings to their factory defaults.

10. Manual

Display this owner's manual.

- ⚠ **Warning:** Do not read the touchscreen while driving. Doing so increases the likelihood of a collision.

Naming Your Vehicle

To further personalize your Model S, you can name it. The name you give your Model S will appear in the mobile app. To name your Model S, touch the Tesla "T" at the top center of the touchscreen, then touch Name Your Vehicle.



When you save, Name Your Vehicle is replaced by the name you provided. You can touch the name at any time to rename your Model S.

Erasing Personal Data

You can erase all personal data (saved addresses, music favorites, imported contacts, HomeLink programming, etc.) and restore all customized settings to their factory defaults. This is useful when transferring ownership of Model S. Touch Controls > Settings > Service & Reset > Factory Reset > Erase & Reset. Before erasing, Model S verifies your credentials by prompting you to enter the user name and password associated with your MY TESLA account.



Overview of Climate Controls

The climate controls are always available at the bottom of the touchscreen. By default, climate control is set to Auto On, which maintains optimum comfort in all but the most severe weather conditions. When you adjust the temperature, the system automatically adjusts the heating, air conditioning, air distribution, air circulation, and fan speed to maintain your selected temperature. To override these settings, touch Auto On (see [Customizing Climate Control](#) on page 105).

The fan, heating, and air conditioning systems are powered by the Battery. Therefore, prolonged use decreases driving range.

Note: The following illustration is provided for demonstration purposes only. Depending on vehicle options, software version, market region, and settings, the information displayed may be slightly different.



1. The front seats are equipped with heating pads that operate at three levels from 3 (highest) to 1 (lowest).

When operating, the indicator turns red and displays the setting number.

Note: If Model S is equipped with the optional cold weather package, you can also control seat heaters in the rear seats, heated wipers, and heated steering wheel by touching Controls > Cold Weather (see [Controls](#) on page 94). When equipped with the optional executive rear seats, you can control the seat and the backrest separately in each second row passenger seat.

2. Touch the up or down arrow to set the cabin temperature (from LO, 63° F to HI, 90° F/LO, 17° C to HI, 32° C). To apply a temperature setting to both the driver and passenger side at the same time, touch SYNC TEMP on the temperature popup that appears when you touch an arrow.
3. Automatic/Manual climate control (see [Customizing Climate Control](#) on page 105).
4. The windshield defroster distributes air flow to the windshield and operates the heating and fan at their maximum level. Touch once for Normal Defrost and twice for Max Defrost. When on, touch again to turn off and restore the air distribution, heating, and fan to their previous settings.
5. Turn climate control system on/off.
6. The rear window defroster warms up the rear window* for 15 minutes, then automatically shuts off. Exterior side mirrors are also heated.

Note: Depending on date of manufacture and options selected at time of purchase, some Model S vehicles are not equipped with a heaters in the exterior side mirrors.

- ⚠ Warning:** To avoid burns resulting from prolonged use, individuals who have peripheral neuropathy, or whose capacity to feel pain is limited because of diabetes, age, neurological injury, or some other condition, should exercise caution when using the climate control system and seat heaters.



Customizing Climate Control

The climate control system is designed to automatically provide optimum comfort in most situations. All you need to do is set the desired temperature, and the air conditioning, air recirculation, air distribution, and fan speed automatically maintain your selected temperature.

To override the automatic setting, touch AUTO to customize individual settings. Then touch the setting you want to change. When you change a setting, the AUTO icon turns from blue to gray and RESET AUTO displays instead. Touch RESET AUTO to change all settings on the panel back to their defaults. Or, you can touch AUTO associated with any individual setting to change it back to its default.

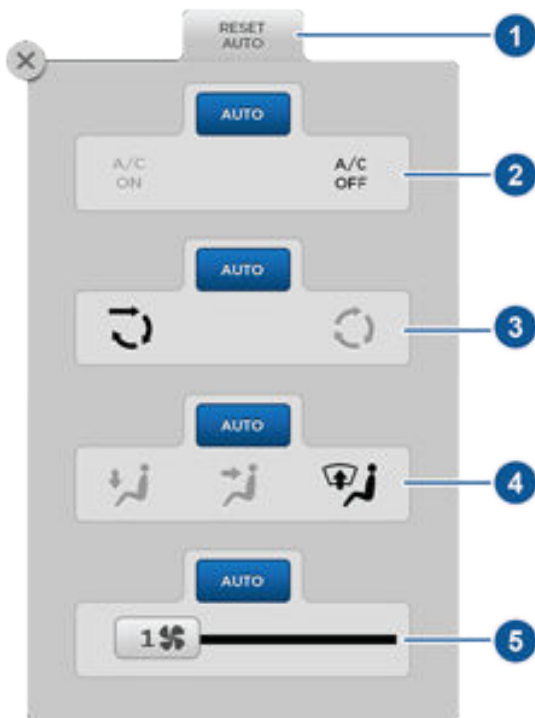



1. Touch RESET AUTO to change all settings back to their default values.
2. Touch A/C ON or A/C OFF to turn the air conditioning on and off, respectively. Turning it off reduces cooling, but saves energy.



Because Model S runs much quieter than a gasoline-powered vehicle, you may notice the sound of the compressor as it is operating. To minimize noise, reduce the fan speed or recirculate the air.



3. Choose how air is drawn into Model S:

	Outside air is drawn into Model S (see Ventilation on page 107). Although less efficient than recirculating the air in very hot or low climate conditions, this setting draws more air into the rear seating areas, and is recommended when occupants are seated in the Tesla built-in rear facing child seats.
	Air inside Model S is recirculated. This prevents outside air (traffic fumes) from entering but reduces dehumidifying performance. Recirculating the air is the most efficient way to cool the front cabin area. To prevent the windshield from fogging in some conditions, briefly change the setting every hour to draw in outside air.

4. Choose where air flows into the cabin. You can choose more than one location:

	Foot-level vents
	Face-level vents
	Windshield vents

Note: When air is directed to the foot-level vents, approximately one third of the air continues to flow to the windshield vents to assist in defogging. However, when air is directed to the face-level vents, no air flows to the windshield because the air flowing through the face-level vents may be adequate to assist in defogging the windshield.

5. Drag the slider to set the speed of the fan.



Ventilation

Outside air is drawn into Model S through the grill in front of the windshield. Keep the grill clear of obstructions such as leaves and snow.

To direct the flow of air inside Model S, move the interior vents up, down, or from side to side.

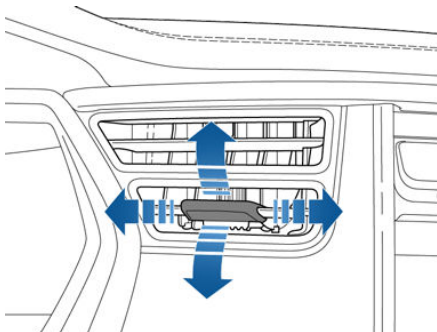

Note: You can direct the outer face level vents toward the side windows to help defrost or defog them.

Cabin Air Filter

Model S has an air filter that prevents pollen, industrial fallout, road dust and other particles from entering through the vents. Tesla replaces the air filter at the regularly scheduled maintenance intervals of every 12 months, or every 12,500 miles (20,000 km).

Climate Control Operating Tips

- When you use the mobile app to turn on the climate control system, it automatically turns off after 30 minutes. To cool or heat the cabin for a longer period, you must turn it on again.
- To conserve energy, you can limit the power of the climate control system by turning on Range Mode. Cabin heating and cooling may be less effective, but seat heaters can be used to provide warmth in colder climates. Touch Controls > Driving > Range Mode.
- If the climate control system operates more loudly than you prefer, reduce the fan speed or adjust the air flow to draw in outside air (instead of recirculating).
- In addition to cooling the interior, the air conditioning system also cools the Battery. Therefore, in hot weather, the air conditioning system can turn on even if you turned it off. This is normal because the system's priority is to cool the Battery to ensure it stays within an optimum temperature range to support long life and optimum performance.
- To ensure the climate control system operates efficiently, close all windows and ensure that the exterior grill in front of the windshield is free of ice, snow, leaves, and other debris.
- To reduce the time it takes to reach a comfortable temperature in hot weather, drive with the windows slightly open for a few minutes when you first start driving.
- In very humid conditions, it is normal for the windshield to fog slightly when you first turn on the air conditioning.
- It is normal for a small pool of water to form under Model S when parked. Extra water produced by the dehumidifying process is drained underneath.
- To reduce the temperature in the cabin in hot weather conditions, the fan may turn on to vent the cabin when the vehicle is parked (this occurs only if the battery's charge level is above 20%).



Note: If Model S is equipped with Smart Air Suspension, you may hear the sound of the compressor when Model S starts, as the system's reservoir fills with air.

Smart Air Suspension has both manual and automatic modes of operation.

Manual Height Adjustments

⚠ Caution: Before adjusting the suspension height, ensure Model S is clear of all obstacles, above and below.

Manually raising the height of Model S is useful when you need extra ground clearance, such as steep driveways or ramps, deep snow, speed bumps, etc.

With Model S powered on, or the brake pedal pressed, use the touchscreen to manually change the ride height. Touch Controls > Suspension, then choose from:

- **Very High.** When set to Very High, the suspension automatically lowers to High when driving speed reaches 22 mph (35 km/h).
- **High.** When set to High, the suspension automatically lowers to Standard when driving speed reaches 34 mph (55 km/h).
- **Standard.** The Standard setting ensures optimum comfort and handling under all loading conditions.
- **Low.** Lowering the height can make it easier to load or unload cargo and passengers.

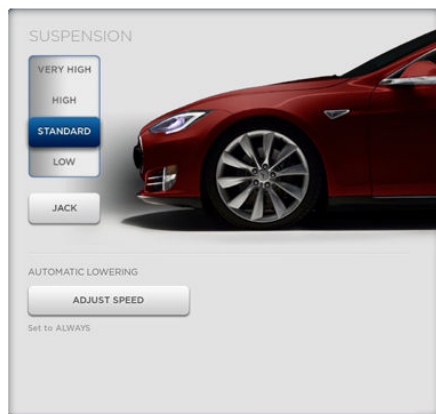

Note: Available settings depend on your driving speed and other conditions. For

example, the suspension does not lower if a door is open.

Location-Based Suspension

Location-Based suspension saves you from manually having to raise the suspension every time you arrive at a frequently-used location where a higher suspension is needed (steep driveways or ramps, deep snow, speed bumps, etc.).

Whenever you raise the suspension to High or Very High, Model S saves the location.

When you return to the saved location, Model S raises the suspension and the instrument panel displays this message:



Note:

- To raise the suspension to High, you must be driving slower than 34 mph (55 km/h). To raise it to Very High, you must be driving slower than 22 mph (35 km/h). If you are driving faster than these speeds when returning to a saved location, the suspension does not raise until Model S slows down.
- After leaving a saved location, the suspension may not lower based on an automatic lowering speed that you have set (Controls > Suspension > Automatic Lowering) until you are driving faster than the auto-raising speed thresholds described above.
- If Model S reaches a saved location and the existing suspension setting is higher than the level that has been saved for that location, the suspension is not adjusted.

To remove an auto-raising location

If you do not want the suspension to auto-raise at a saved location, touch the X in the auto-raising location status message that displays at a saved location. Doing so removes the auto-raise location and the suspension no longer raises automatically when you arrive at the location.

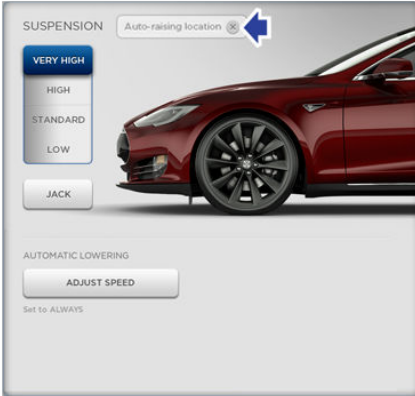

Note: Manually lowering the suspension to Standard or Low while at a saved location also removes the auto-raising location.

Automatic Lowering

When Model S is moving above typical driveway or parking lot speeds, Smart Air Suspension automatically lowers ride height to improve aerodynamics and handling. For most average speed driving, the suspension is automatically set to Standard. As described above, when you make manual height adjustments, the suspension automatically lowers at increased driving speeds.

When carrying loads, Smart Air Suspension also maintains a level height between the front and rear.

You can adjust the speed at which the Air Suspension automatically transitions to the LOW ride height by touching Controls > Suspension > Automatic Lowering on the touchscreen. This setting is saved to your Driver Profile.

Note: You can temporarily override the ride height by pressing the brake pedal, touching an air suspension control in Controls > Suspension, and then manually choosing a ride height. Your suspension's automatic lowering setting is restored the next time you drive.



If a fault is detected with the air suspension system, a yellow indicator lights up on the instrument panel. If the problem persists, contact Tesla.

Jack Mode

Before jacking or lifting, set the suspension to Jack mode to prevent the self-leveling that occurs even when Model S is powered off.

Press the brake pedal, then touch Controls > Suspension > Jack.



When Model S is in Jack mode, a red air suspension indicator lights up on the instrument panel.

To deactivate, touch Jack again.

Note: Jack mode automatically cancels when you drive over 4.5 mph (7 km/h).



Overview

Touch the Media icon to listen to the radio or play audio files. The touchscreen displays the Media Player. Media Player has two tabs. Use the Browse tab to select what you want to play and use the Now Playing tab to view and control what is currently playing. You can play AM and FM radio (including HD), and XM satellite radio (if Model S is equipped with the optional sound package). You can also play Internet radio (such as TuneIn), and audio files from a Bluetooth-connected device or a USB-connected flash drive.

Volume Control

To adjust the media volume, roll the scroll wheel on the left side of the steering wheel up or down. To mute the volume, tap the scroll wheel.

Note: The scroll wheel adjusts the volume for media, navigation instructions and phone calls based on what is currently in use. As you adjust volume, the instrument panel displays the volume level and whether you are adjusting volume for media, navigation or phone.

Note: Muting the volume during a phone call also mutes the microphone.

AM and FM Radio

Model S provides AM and FM radio services. These can be selected from the Browse tab or using the Source Picker, located in the upper right corner of the Media Player window.

You can manually tune the radio to any frequency by touching and dragging the channel selector bar on the Now Playing screen. The channel selector bar allows you to move from one available radio station to the next.

XM Radio

If Model S is equipped with the optional sound studio package, you can listen to XM radio, a subscription-based satellite radio service. To receive XM radio channels, you must provide the radio service provider with the radio ID for your touchscreen.

To view the radio ID:

1. Select the XM radio source.
2. Tune it to channel 0.

3. The Radio ID displays in the station information area.

To select an XM radio channel, you can either manually scroll through the channel numbers, or you can browse the channels by category. To browse by category, touch Browse > Radio > XM Satellite Radio.

Note: On some vehicles, XM radio is available only if Model S is equipped with both the optional sound studio package and the panoramic roof. To optimize aerodynamics, Model S does not have an external antenna. The internal antenna is compatible only with the transparent panoramic roof.



Internet Radio

Internet radio services are accessed over a data connection. To use Internet radio, touch Media > Browse > Internet.

Choose your desired Internet radio service (for example, TuneIn), then browse through the available categories and/or stations. When you select a specific station or episode, Media Player starts playing it and displays the Now Playing screen.

To play the next (and in some cases previous) available station, episode, or track being provided by the Internet radio service, touch the arrows on the Now Playing screen, or use the buttons on the left side of the steering wheel (see [Using Left Steering Wheel Buttons](#) on page 37). The exact function of these controls vary depending on the specific Internet service you are listening to.

You can also use voice commands to play a specific song, artist, or album from an Internet radio service (see [Using Voice Commands](#) on page 39).

Internet Radio Account Registration

Model S provides you with one or more Internet radio services. To enter your log in information, touch Controls > Settings > Apps > Media Player. Enter the email and password associated with the Internet radio account(s) you want to use, then touch Log In.

Slacker

Model S automatically provides you with a complimentary 12-month Slacker Plus account. Tesla has set up this account for you and there is no need to log in. To use your own Slacker Plus or Premium account, log in as described above.

Note: To shuffle tracks, or repeat a track, using the shuffle/repeat icons provided on the Now Playing tab, you must be listening to a prebuilt playlist in a Slacker Premium account.

Note: To use Slacker Premium, you must purchase your own account (go to www.slacker.com).

Note: Model S does not support basic (free) Slacker services.

TuneIn

TuneIn does not require an account for it to work. But if you have a TuneIn account (go to www.tunein.com), you can log in as described above.

When playing a TuneIn podcast, you can rewind or fast forward to any location in the podcast by dragging the slider bar on the Now Playing tab.



Media Settings

To adjust settings for your radio stations, and to log into your Internet radio account(s), touch Controls > Settings > Apps > Media Player.

Favorites



To add a currently playing radio station or audio file to your Favorites list, touch the Favorites icon on the Now Playing screen. The icon turns blue to show that it is a favorite. To remove a favorite, touch the icon again.

Note: Adding a radio station to your Favorites list also assigns it to one of the six presets, if an empty preset is available.

Note: To select a favorite radio station or audio file, you can browse your list of Favorites by touching Browse > Favorites. As shown below, the Favorites are grouped and sorted by their source (FM, etc.).

To play the previous or next song or station in your Favorites list, touch the previous or next icon on the Now Playing screen, or use the buttons on the left side of the steering wheel (see [Using Left Steering Wheel Buttons](#) on page 37).

To remove a favorite from the list, touch the associated X.

Note: If you remove a favorite radio station or channel that is assigned to a preset, it is also removed from the preset.

My Music & Devices

To play audio files from a USB-connected flash drive or a Bluetooth-connected device, touch Media > Browse > My Music & Devices. The name of the device will be displayed. Touch the song, album, or playlist you want to play and Media Player starts playing and displays the Now Playing screen.

To play the next song in the selected playlist or album, touch the previous or next arrows on the Now Playing tab, or use the buttons on the left side of the steering wheel (see [Using Left Steering Wheel Buttons](#) on page 37). You can also shuffle tracks in a playlist or repeat any track using the shuffle/repeat icons displayed below the album cover art.

USB Connected Flash Drives

Connect a flash drive to one of the USB connections (see [USB Hub Connections](#) on page 113). Touch Media > Browse > My Music & Devices, then touch the name of the flash drive and the song you want to play.

Note: To play media from a USB connection, Model S recognizes flash drives only. To play media from other types of devices (such as an iPod), connect using Bluetooth (if supported by the device).

Bluetooth[®] Connected Devices

If you have a Bluetooth-capable device such as a phone that is paired and connected to Model S (see [Pairing a Bluetooth Phone](#) on page 114), you can play audio files stored on it, and you can stream a music service (for example, Pandora). Touch Media > Browse > My Music & Devices, then touch the name of your Bluetooth-connected device.

Your Bluetooth device begins playing the audio file that was currently active on your device, and the touchscreen displays the Now Playing screen.

To change the track playing, touch the previous or next icons on the touchscreen, or use the buttons on the left side of the steering wheel.

Note: To play media from a Bluetooth-connected device, ensure that access to the device's media is turned on (see [Phone](#) on page 114).



USB Hub Connections

Your Model S has two USB connections located on the front of the center console that you can use to connect USB devices. To play audio files stored on a USB drive connected to these ports, see [My Music & Devices](#) on page 112. You can also use these connections to charge USB devices.

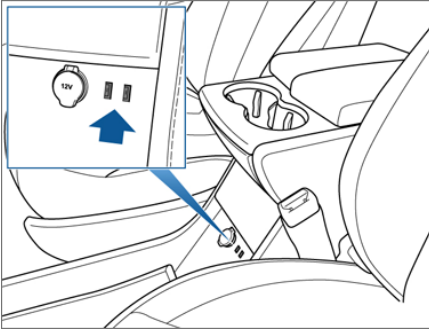

Note: Do not connect multiple devices using a USB hub. This can prevent connected devices from charging or from being recognized by the Media Player.

12V Power Socket

Your Model S has a power socket located on the front of the center console. Power is available whenever the instrument panel and touchscreen are on.

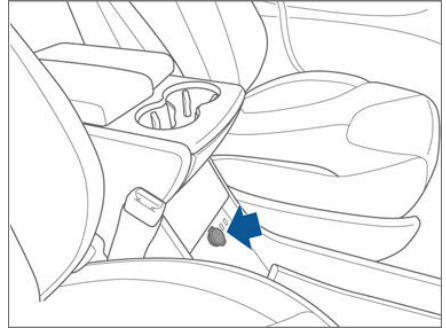

The 12V power socket is suitable for accessories requiring up to 11A continuous draw (15A peak) or a maximum of 150 continuous watts (180 watts peak).

Note: In situations where Model S is unable to detect the key (low battery, interference, etc.), place it immediately below the 12V power socket where Model S can best detect it.

⚠ Warning: The power socket and an accessory's connector can become hot.



Bluetooth^{fi} Compatibility

You can use your Bluetooth-capable phone hands-free in Model S provided your phone is within operating range. Although Bluetooth typically supports wireless communication over distances of up to approximately 30 feet (9 meters), performance can vary based on the phone you are using.

Before using your phone with Model S, you must pair it. Pairing sets up Model S to work with your Bluetooth-capable phone (see [Pairing a Bluetooth Phone](#) on page 114).

You can pair up to ten Bluetooth phones. Model S always automatically connects to the last phone that was used (provided it is within range). If you want to connect to a different phone, see [Connecting to a Paired Phone](#) on page 115.

Note: On many phones, Bluetooth turns off if the phone's battery is low.

Note: In addition to phones, you can also pair Bluetooth-enabled devices with Model S. For example, you can pair an iPod Touch or an iPad or Android tablet to stream music.

Pairing a Bluetooth Phone

Pairing sets up Model S to work with your Bluetooth-capable phone. Once a phone is paired, Model S can connect to it whenever the phone is within range.

To pair a phone, follow these steps while sitting inside Model S:

1. Ensure both the touchscreen and the phone are powered on.
2. On the touchscreen's status bar, touch the Bluetooth icon.
3. On your phone, enable Bluetooth and set it to discoverable.
4. On the Model S touchscreen, touch Start Search. The touchscreen searches then displays the list of all available Bluetooth devices within operating distance.
5. On the Model S touchscreen, touch the phone with which you want to pair. Within a few seconds, the touchscreen displays a randomly generated number, and your phone should display the same number.
6. Check that the number displayed on your phone matches the number displayed on the touchscreen. Then, on your phone, confirm that you want to pair.

When paired, Model S automatically connects to the phone, and the touchscreen displays the Bluetooth symbol next to the phone's name to show that the connection is active.

Importing Contacts

Once paired, you can use the Bluetooth settings screen to specify whether you want to allow access to your phone's contacts and recent calls.

If access is turned on, you can see your list of contacts on the Model S touchscreen. Touch Phone > Contacts. You can then touch a contact to dial its phone number or navigate to its address.

Note: Before contacts can be imported, you may need to either set your phone to allow syncing, or respond to a popup on your phone to confirm that it is OK to sync contacts. This varies depending on the type of phone you are using. For details, refer to the owner documentation provided with your phone.

If access is turned on, imported information is displayed when you touch the contacts tab on the Phone app.

Note: For security reasons, erase your contacts if you sell Model S (see [Erasing Personal Data](#) on page 103).

Unpairing a Bluetooth Phone

If you want to disconnect your phone and use it again later, simply touch Disconnect on the Bluetooth settings screen. If you do not want to use your phone with Model S again, touch Forget This Device. Once you forget a device, you need to pair it again if you want to use it with Model S (see [Pairing a Bluetooth Phone](#) on page 114).

Note: Your phone automatically disconnects whenever you leave Model S.



Connecting to a Paired Phone

Model S automatically connects with the last phone to which it was connected, provided it is within operating range and has Bluetooth turned on. If the last phone is not within range, it attempts to connect with the next phone that it has been paired with.

To connect to a different phone, touch the Bluetooth icon on the touchscreen's status bar. The Bluetooth window displays a list of paired phones. Choose the phone you want to connect to, then touch Connect. If the phone you want to connect to is not listed, follow the instructions on [Pairing a Bluetooth Phone](#) on page 114.

When connected, the Model S touchscreen displays the Bluetooth symbol next to the phone name to show that the connection is active.

Making a Phone Call

You can make a phone call by:

- Speaking a voice command (see [Using Voice Commands](#) on page 39).
- Choosing a contact from your contact list (described above).
- Using the Model S on-screen dialer.

To make a phone call using the on-screen dialer:

1. Touch the Phone app on the touchscreen, then touch Dialer.
2. Enter the phone number on the dialer.
3. Touch Call. The touchscreen displays the call screen and the number you are calling.

To make a phone call by choosing a contact:

1. Touch the Phone app on the touchscreen, then touch Contacts.
Note: Ensure that access to the phone's contacts is turned on.
2. Touch the name of the contact you want to call to display details about the contact.
3. Touch the number you want to dial (there may be more than one). The touchscreen displays the call screen and the name of the contact you are calling.

Note: If it is safe and legal to do so, you can also initiate a call by dialing the number or selecting the contact directly from your phone.

Receiving a Phone Call

When your phone receives an incoming call, both the instrument panel and the touchscreen display the caller's number or name (if the caller is in your phone's contact list and Model S has access to your contacts).

Touch one of the options on the touchscreen, or use the scroll wheel on the right side of the steering wheel to Answer or Ignore the call (see [Using Right Steering Wheel Buttons](#) on page 38).

In Call Options

When a call is in progress, you can display the call menu on the instrument panel by pressing the top button on the right side of the steering wheel. Then use the right scroll wheel to scroll through and choose an option (see [Using Right Steering Wheel Buttons](#) on page 38). To adjust the call volume, roll the steering wheel's left scroll wheel during a call.



Overview

Touch the Maps (or Nav) icon to view and search for a location on Google Maps™. If Model S is equipped with the Navigation option, the app is labeled Nav, and onboard maps are available. Onboard maps allow you to navigate to any location, even if a data connection is not available. When you specify a location, the touchscreen displays the route and provides turn-by-turn instructions. If Model S is not equipped with the Navigation option, onboard maps are not available, but if you have a data connection, you can find and display any location.

Using Maps

Touch the search field, or speak a voice command to specify a location (for details on how to use voice commands, see [Using Voice Commands](#) on page 39). You can enter or speak an address, landmark, business, etc. You can also touch PLACES and choose from a list of recent locations and searches, Favorite destinations, Supercharger locations, and charging stations you've visited. To mark a destination as a Favorite, select its "pin" (from search results or "Recents"), and then touch the heart icon.

If Model S is equipped with the Navigation option, you can drop a pin anywhere on the map by pressing and holding a spot on the map. You can navigate to the pin's location or save the pin as a Favorite (see [Favorite Destinations](#) on page 118).

Touch the North/Heading Up icon to the right of the search bar to center the map on your car and have the map track your position as you drive. The icon is blue when the map is tracking your position and by touching the icon, you can change the orientation of the map:



North Up - North is always at the top of the screen.



Heading Up - The direction you are heading is always at the top of the screen. The map rotates when you change direction.

You can rotate the map in any direction. When you rotate the map you'll notice the icon turn gray, indicating the map is no longer tracking your position. Touch the icon again to track your position.



Whenever the map is in the Heading Up orientation, a compass appears on the map. The arrow on the compass points North and the text on the compass indicates the direction you are driving. You can touch the compass to switch to North Up (described above).

Starting Navigation

1. Touch the Nav icon to display the map.
2. Touch the search bar to enter the destination, then touch GO. You can also use voice commands to specify the destination (see [Using Voice Commands](#) on page 39). If you have a data connection, you can start entering the destination, then choose one of the auto-complete entries that appear. For example, you can enter just the street, business name, or category (such as hotels, coffee, etc.). If you don't have a data connection, you must enter complete and exact location information.

A list of matching destinations appears on the left, and their corresponding pins (with letters A, B, C, etc.) appear on the map.

Note: You can also touch PLACES and choose a location from the list of Recent locations and searches, Favorite locations, Supercharger locations, destination charging, or Visited Chargers.

3. Touch any destination in the list to immediately start navigation, or touch the lettered pin on the map to view the destination popup, which also allows you to place a phone call to the destination (in situations where a phone number is available).

Note: If you have set up your phone's calendar to work with Model S, and a calendar event includes a specific location, you are given the option to navigate to the location (see [Calendar](#) on page 119).

During Navigation

During navigation, the touchscreen displays the navigation route on the map. Depending on the map's zoom level, you might not be able to see the entire route. But as you drive, the map shows your location on the map. Whenever a navigation route is active, you can display the full route on the map by touching the route overview icon:



The route overview icon is available on the right side of the search bar whenever a navigation route is active. You can toggle between North Up, Heading Up, and Route Overview (see [Using Maps](#) on page 116). As you travel on your navigation route, the zoom level adjusts to display an overview of the route and zooms in on your destination as you make progress on your trip.

The touchscreen also displays a turn-by-turn direction list that includes estimated driving time and arrival time.

During navigation, the instrument panel also displays the turn-by-turn directions and you will hear spoken instructions. To change the volume of the spoken instructions use the scroll wheel on the left side of the steering wheel when the navigation instructions are being spoken. You can also touch the volume button located on the turn-by-turn direction list displayed on the touchscreen.

Model S detects real-time traffic conditions and automatically adjusts the estimated driving and arrival times based on traffic conditions. In situations where traffic conditions will delay your estimated time of arrival and an alternate route is available, Model S reroutes you to your destination. You can turn this feature off by touching **Controls > Settings > Apps > Maps & Navigation > Traffic-Based Routing > Off**.

When you display the traffic layer on the map, green traffic lines display under the route line, whereas yellow and red traffic lines display on top of the route line to ensure that heavy traffic areas are easy to identify.

Model S can also monitor traffic to your work location (on weekday mornings) and to your home location (on weekday evenings) and advise you if there is a better route in situations where traffic conditions will cause a delay. You can set the time savings required before the advice is given by touching **Controls > Settings > Apps > Maps & Navigation > Min Improvement for Commute Advice**.

As you approach an upcoming turn on your navigation route, a vertical progression bar displays on the right side of the touchscreen's turn-by-turn direction list. This vertical bar also displays on the right side of the navigation instructions on the instrument panel. As you progress toward the location where you will need to make a turn, the bar fills, from bottom to top. When you arrive at the location of the turn, the bar is completely filled.

Note: Commute advice is available only if you have saved a Home and Work Location (see [Favorite Destinations](#) on page 118).

Predicting Energy Usage

When navigating to a destination, Model S helps you anticipate your charging needs by calculating the amount of energy that will remain when you reach your destination. The calculation is an estimate based on driving and environmental factors such as predicted speed and elevation changes. The touchscreen displays this calculation at the bottom of the turn-by-turn direction list when you first initiate the navigation route. Thereafter, you can display it by touching the area at the bottom of the turn-by-turn direction list.

Throughout your route, Model S monitors energy usage and updates the calculation as needed. A popup warning displays at the bottom of the turn-by-turn direction list in these situations:

- A yellow warning displays when you should drive slowly to conserve energy. Model S predicts that you will have very little energy remaining when you reach your destination. For tips on conserving energy, see [Getting Maximum Range](#) on page 62.
- A red warning displays when you must charge Model S to reach your destination.

Model S also lets you know if you have enough energy for a round trip. Tap the battery icon at the bottom of the turn-by-turn navigation list to determine if Model S has enough energy to get to your destination and then return back to your starting point.

When navigating, you can also use the Energy app to monitor energy usage while on your trip (see [Getting Maximum Range](#) on page 62).



Trip Planner

Trip Planner helps you take longer road trips with confidence. If reaching your destination requires charging, Navigation routes you through the appropriate supercharger locations. Trip Planner selects a route that minimizes the time you spend driving and charging.

After selecting a destination, touch Trip on the bottom left of the turn-by-turn direction list to display the Trip Overview, which shows:

- The list of supercharger stops.
- The charging time required at each supercharger stop.
- Estimated amount of battery energy available when you arrive at the first supercharger location.

Touch Resume to return to the turn-by-turn direction list at any time.

While charging at each supercharger stop, the charging screen displays the remaining charge time needed for your trip.

Note: If a supercharger located on your existing route experiences an outage, Trip Planner displays a notification and reroutes you to a different supercharger location.

Favorite Destinations



Add any destination to your list of Favorites by either touching its flag while navigating to it, or by displaying it on the map then touching its pin. Then, in the popup dialog that appears, touch the Favorites icon. When a destination is on your Favorites list, the icon is blue. To remove a favorite destination, touch the Favorites icon again.

If you frequently navigate to a destination, you may want to add it as a Favorite to avoid having to enter the location's name or address each time. When you add a destination as a Favorite, you can easily navigate to it by touching PLACES, then selecting it from the list of Favorites. The Favorites list has placeholders for your Home and Work locations. In fact, Model S may prompt you to save a current location as Home or Work based on your usage pattern.

Note: For security reasons, erase your favorite destinations if you sell Model S (see [Erasing Personal Data](#) on page 103).

Updated Maps

To receive updated Maps, periodically connect Model S to a Wi-Fi network (see [Connecting to Wi-Fi](#) on page 124). As updated Maps become available, they are sent to Model S over Wi-Fi only. The touchscreen displays a message informing you when new Maps have been installed.



Overview

The Calendar app allows you to view your phone's (iPhone[®] or Android[™]) calendar for the current and next day. The Calendar app requires that:

- The Tesla Model S mobile app is running and you are logged in. When prompted on your phone, you must grant calendar access to the mobile app. The mobile app can then periodically (and automatically) send calendar data from your phone to Model S. Also, whenever you display the mobile app on your phone, updated calendar data is sent to Model S. To ensure you have access to all features of the Calendar app, you will need the latest version of the mobile app.
- Your phone is connected to Model S via Bluetooth (for privacy reasons, calendar data displays only from a phone that is connected via Bluetooth).
- Remote access to Model S is turned on (touch Controls > Settings > Safety & Security > Remote Access > On).
- Both your phone and Model S have good connectivity.

When you enter Model S, the touchscreen can display a reminder of the day's events. You can customize if and when your calendar events are displayed by touching Controls > Settings > Apps > Calendar > Show Calendar Upon Entry.

To view scheduled events for the next 48 hours, choose the Calendar app from the main touchscreen window. The Calendar app displays events in chronological order.

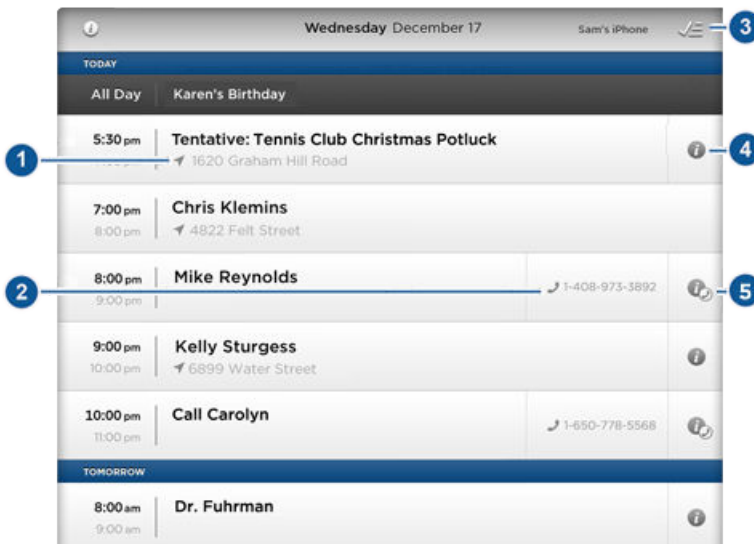

1. If the calendar event includes an address, a navigation arrow displays to indicate that you can touch the address to navigate to the event's location (if your Model S is equipped with Navigation).
2. If a phone number is associated with a calendar event, you can touch the number to initiate a phone call.
3. In situations where events are displayed from multiple calendars, you can filter to show only events from one or more specific calendars.
4. If the calendar event has notes associated with it, touch the information icon to display the notes in a pop up window.



5. If an event's notes include one or more phone numbers, a phone symbol displays with the information icon and the first phone number found in the notes displays on the event list and you can use this number to initiate a phone call (as described in item 2 above). But you can also initiate a call from within the notes pop up window by referencing other numbers that are included in the notes (this is particularly useful for conference calls). If the notes contain a web link, you can touch the link to open it in the Web Browser app.

Calendar and Navigation

If Model S is equipped with navigation, and a calendar event has a location specified, you will be given the option to navigate to that location. Also, when an event on your Calendar takes place within the next hour and has a uniquely specified location, the Model S navigation system notifies you if there is a better route due to traffic, even if you're not using navigation.



About the Security System

If Model S does not detect a key nearby and a locked door or trunk is opened, an alarm sounds and headlights and turn signals flash. To deactivate the alarm, press any button on the key.

To manually enable or disable the alarm system, touch Controls > Settings > Safety & Security > Alarm. When set to on, Model S activates its alarm one minute after the doors lock and a recognized key is no longer detected nearby.



About HomeLink

You can program the HomeLink^{fi} Universal Transceiver to operate up to three garage doors, gates, lights, and security systems that can transmit Radio Frequency (RF) signals.

Note: Depending on date of manufacture and options selected at time of purchase, some Model S vehicles are not equipped with HomeLink.

Programming HomeLink



1. Park Model S in front of the device you want to program, and have the device's remote control ready.
2. Touch Controls > Settings > HomeLink on the touchscreen.
3. Touch Add New HomeLink, then use the onscreen keyboard to enter a name for your HomeLink device.
4. Touch Program.
5. Follow the onscreen instructions.

Once programmed, you can operate the device by touching its corresponding HomeLink icon on the touchscreen's status bar. HomeLink remembers the location of your programmed devices. When you approach a known location, the HomeLink control on the touchscreen automatically drops down. When you drive away, it disappears.

To operate a device without having to touch the screen, you can automate it so it opens or closes automatically as you approach or drive away, respectively. To do so, touch Controls > Settings > HomeLink, touch the name of your device, then select the Auto Open and/or the Auto Close checkbox(es). As you approach (or drive away from) a device that is set to operate automatically, the HomeLink status icon displays the device name indicating that it has been automated. As you approach, a count-down message displays to let you know when the device will automatically open. In situations where you don't want the device to automatically open or close, touch Skip Auto-Open or Skip Auto-Close at any time during the count-down message.

Note: For security reasons, erase your HomeLink settings if you sell Model S. To do so, touch Controls > Settings > HomeLink, touch the name of your device, then touch Delete. You can also erase your HomeLink settings, along with all other personal data (saved addresses, music favorites, imported contacts, etc.), by touching Controls > Settings > Service & Reset > Factory Reset >

Erase & Reset (see [Erasing Personal Data](#) on page 103).

-  Warning: Your device might open or close during programming. Before programming, make sure that the device is clear of any people or objects.
-  Warning: Do not use the HomeLink Universal Transceiver with a garage door that does not meet safety standards. A garage door opener that cannot detect an object in its path and then automatically stop and reverse, does not meet these standards. Using a garage door opener without these features increases the risk of injury or death.

Resetting the Location of the HomeLink Device

If you experience situations in which you sometimes drive up to your HomeLink Device and it doesn't open, or the HomeLink icon on the touchscreen's status bar does not display the dropdown when you approach the device, you may need to reset the device's location. To do so, park as close as possible to the HomeLink device (garage door, gate, etc.) and display the HomeLink settings page by touching Controls > Settings > HomeLink. Choose the name of the programmed device, and touch Reset Location.

Troubleshooting HomeLink

When programming a HomeLink device, the touchscreen steps you through a two-part programming process:

- First, Model S records the signal from the remote. The touchscreen instructs you to stand in front of the car, point the remote at the front bumper and press and hold the button until the headlights flash. When headlights flash, Model S has learned the remote and you can touch Continue on the touchscreen. If the headlights do not flash, refer to the guidelines below.



- Next, the device's receiver learns Model S. The touchscreen instructs you to press the LEARN button on the garage door or gate's receiver. If training the receiver does not work, refer to the guidelines below.

NOTE: Only devices that are equipped with a "rolling code" remote need to learn Model S. If you have a very old device that is not equipped with a rolling code remote, the device does not need to learn Model S and you can skip this part. You can also skip this step if your receiver is Quick-Train compatible. The opener should work.

Headlights do not flash

- Check the batteries in the remote. It is a good idea to replace the batteries before you start programming.
- Hold the remote against the nose cone, with the button pressed, about 6 inches to the left of the Tesla emblem. In some cases you must hold the remote for up to three minutes.
- Check compatibility of the remote by contacting the HomeLink manufacturer (www.homelink.com).

After programming, the device does not work

- Park Model S with its front bumper as close as possible to the HomeLink device (garage door, gate, etc).
- Make sure you haven't reached the device receiver's limit of learned remotes/cars. Most receivers can learn up to five remotes/cars. If the receiver's memory is full, you must clear the memory and restart the programming process. For instructions on how to clear the receiver's memory, refer to the owner documentation provided with the HomeLink device.
- Make sure you are pressing the receiver's LEARN button. Most receivers have two buttons and a LED. One button is a RESET button and the other is a LEARN button. Pressing the LEARN button usually causes the LED to flash. For instructions on how to put the receiver into learning mode, refer to the owner documentation provided with the HomeLink device.
- Most devices stay in learning mode for only three to five minutes. Immediately after pressing the device's LEARN button, follow the instructions displayed on the touchscreen.



Wi-Fi is available as a data connection method and is often faster than cellular data networks. Connecting to Wi-Fi is especially useful in areas with limited or no cellular connectivity. To ensure fast, reliable delivery of Model S updates (see [Software Updates](#) on page 125), Tesla recommends leaving Wi-Fi turned on and connected to a Wi-Fi network. To connect to a Wi-Fi network:

1. Touch the 3G (or LTE) icon in the touchscreen status bar. Model S will start scanning and display the Wi-Fi networks that are within range.
2. Select the Wi-Fi network you want to use, enter the password (if necessary), then touch Connect.

You can also connect to a hidden network that isn't shown on the list of scanned networks. Just touch Wi-Fi Settings and enter the name of the network in the resulting dialog box.

Once you have connected to a network, Model S auto-connects whenever the network is within range. If more than one previously connected network is within range, Model S connects to the one most recently used.

Note: You can also use a mobile hotspot or your phone's Internet connection via Wi-Fi tethering.

Note: At Tesla service centers, Model S automatically connects to a Tesla Service Wi-Fi access point.



Loading New Software

Model S updates its software wirelessly, providing new features throughout your term of ownership. The first time you enter Model S after an update is made available, a scheduling window displays on the touchscreen.

Note: Some software updates can take from two to three hours to complete. Model S must be in P (Park) when the new software is being installed. To ensure the fastest and most reliable delivery of software updates, leave the Wi-Fi turned on and connected whenever possible (see [Connecting to Wi-Fi](#) on page 124).

When a software update is available, a yellow clock icon appears on the touchscreen's status bar. Touch the clock icon to display the update window. You can then either:

- Schedule the update by setting the time you want the update to begin. Then touch Set For This Time. Once scheduled, the yellow clock icon on the touchscreen's status bar becomes white. You can reschedule the update any time before it begins.

OR

- Touch Install Now to immediately start the update process.

If Model S is charging when the software update begins, charging stops. Charging resumes automatically when the update is complete. If you are driving Model S at the scheduled update time, the update is canceled and you need to reschedule.

If the touchscreen displays a message indicating that a software update was not successfully completed, contact Tesla.

Viewing Release Notes

When a software update is complete, learn about the new features by displaying the release notes. To display release notes at any time touch the Tesla "T" at the top center of the touchscreen, then touch Release Notes.



Model S Mobile App

The Tesla Model S mobile app allows you to communicate with Model S remotely using your iPhone[®] or Android[™] phone. With this app, you can:

- Check charging progress and receive notifications when charging has started, has been interrupted, or is complete.
- Heat or cool Model S before driving (even if it's in a garage).
- Locate Model S with directions, or track its movement across a map.
- Flash lights or honk the horn to find Model S when parked.
- Vent or close the sunroof.
- Lock or unlock Model S from afar.
- Start Model S.
- Support the Model S Calendar app by allowing the mobile app to send your phone's calendar data to Model S.
- Receive notifications when the car alarm has been triggered, or a new Model S software update is available.

Simply download the Tesla Model S mobile app to your phone and enter your MY TESLA login credentials. You must also ensure that Model S is ready to communicate with the mobile app by turning on its remote access setting. Touch Controls > Settings > Safety & Security > Remote Access > On (see [Settings](#) on page 99).

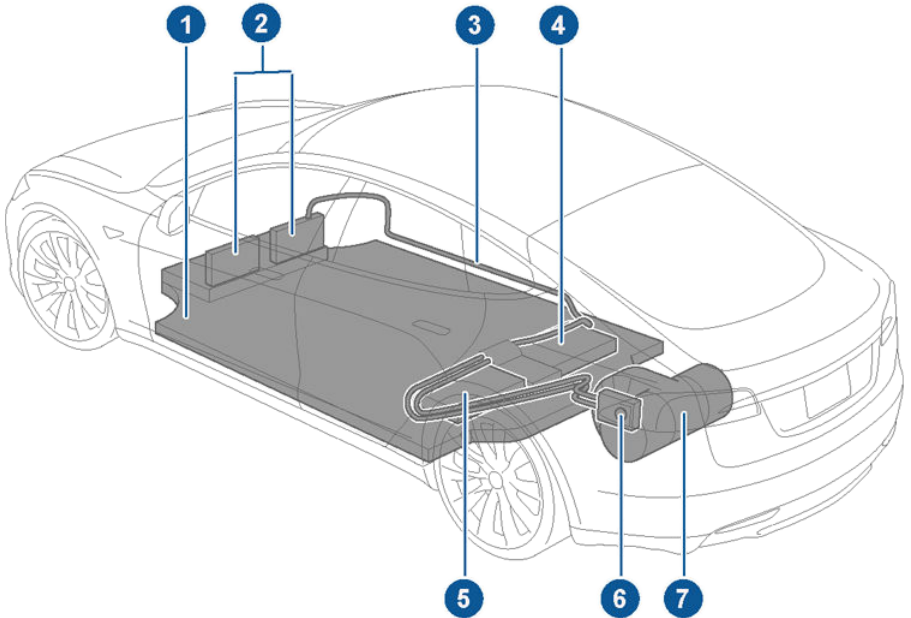

Note: Tesla does not support the use of third party applications to contact Model S.

High Voltage Components



1. Battery
2. DC-DC converter and junction box
3. High voltage cabling (colored orange)
4. 10 kW on-board master charger
5. OPTIONAL: 10 kW on-board charger
6. Charge port
7. Motor



-  Warning: The high voltage system has no user serviceable parts. Do not disassemble, remove or replace high voltage components, cables or connectors. High voltage cables are colored orange for easy identification.
-  Warning: Read and follow all instructions provided on the labels that are attached to Model S. These labels are there for your safety.
-  Warning: In the unlikely event that a fire occurs, immediately contact your local fire emergency responders.

Charging Equipment

Charging equipment designed specifically to charge your Model S is available from Tesla. A Tesla Wall Connector, which installs in your garage, is the fastest way to charge Model S at home.

In several market regions, Model S is equipped with a Mobile Connector and the adapter(s) you need to plug into commonly used power outlets. When using the Mobile Connector, first plug the Mobile Connector into the power outlet, then plug in Model S. For more information about your Mobile Connector, see the Mobile Connector Owner's Manual (available on the touchscreen). Additional adapters can be purchased from Tesla.

Tesla also provides various types of adapters (including J1772, Mennekes Type 2, and CHAdeMO) that allow you to plug Model S into the most commonly used public charging stations in your region. Connect the adapter to the charging station's charge cable, open the charge port door using the touchscreen (see [Charging Instructions](#) on page 130), then plug in Model S.

For more information on the charging equipment available for your region, go to www.teslamotors.com, choose your region, then view the available charging options.



About the Battery

Model S has one of the most sophisticated battery systems in the world. The most important way to preserve the Battery is to LEAVE YOUR Model S PLUGGED IN when you are not using it. This is particularly important if you are not planning to drive Model S for several weeks. When plugged in, Model S wakes up when needed to automatically maintain a charge level that maximizes the lifetime of the Battery.

There is no advantage to waiting until the Battery's level is low before charging. In fact, the Battery performs best when charged regularly.

Note: If the Model S Battery becomes completely discharged in a situation in which towing is required, the owner is responsible for towing expenses. Discharge-related towing expenses are not covered under the Roadside Assistance policy.

Battery Care

Never allow the Battery to fully discharge. Even when Model S is not being driven, its Battery discharges very slowly to power the onboard electronics. On average, the Battery discharges at a rate of 1% per day. Situations can arise in which you must leave Model S unplugged for an extended period of time (for example, at an airport when traveling). In these situations, keep the 1% in mind to ensure that you leave the Battery with a sufficient charge level. For example, over a two week period (14 days), the Battery discharges by approximately 14%.

Discharging the Battery to 0% may permanently damage the Battery. To protect against a complete discharge, Model S enters a low-power consumption mode when the charge level drops to 5%. In this mode, the Battery stops supporting the onboard electronics to slow the discharge rate to approximately 4% per month. Once this low-power consumption mode is active, it is important to plug in Model S within two months to avoid Battery damage.

Note: When the low-power consumption mode is active, the auxiliary 12V battery is no longer being charged and can completely discharge within 12 hours. In the unlikely event that this occurs, you may need to jump start or replace the 12V battery before you can charge. In this situation, contact Tesla.





Temperature Limits

For better long-term performance, avoid exposing Model S to ambient temperatures above 140° F (60° C) or below -22° F (-30° C) for more than 24 hours at a time.

Energy Saving Feature

Model S has an energy-saving feature that reduces the amount of energy being consumed when Model S is not in use. Touch Controls > Displays > Energy Saving. For more information on maximizing range and saving energy, see [Getting Maximum Range](#) on page 62.

Battery Warnings and Cautions

-  **Warning:** The Battery has no parts that an owner or a non-Tesla authorized service technician can service. Under no circumstances should you open or tamper with the Battery. Always contact Tesla to arrange for Battery servicing.
-  **Caution:** If the Battery's charge level falls to 0%, you must plug it in. If you leave it unplugged for an extended period, it may not be possible to charge Model S or use the vehicle without jump starting or replacing the 12V battery. Leaving Model S unplugged for an extended period can also result in permanent Battery damage. If you are unable to charge Model S, contact Tesla immediately.
-  **Caution:** The Battery requires no owner maintenance. Do not remove the filler cap and do not add fluid. If the instrument panel warns you that the fluid level is low, contact Tesla immediately.
-  **Caution:** Do not use the Battery as a stationary power source. Doing so voids the warranty.



Opening the Charge Port

The charge port is located on the driver's side of Model S, behind a door that is part of the rear tail light assembly.

Park Model S so that the charge cable easily reaches the charge port.

With Model S unlocked, or a recognized key nearby, press and release the button on a Tesla charge cable to open the charge port door. If the cable you are using does not have this button, you can also open the charge port door using any of these methods:

- Touch Controls > Charge Port on the touchscreen.
- Hold down the rear trunk button on the key for 1-2 seconds.



To charge at a public charging station, attach an adapter to the station's charging connector. The most commonly used adapter(s) for each market region are supplied with Model S. Depending on the charging equipment you are using, you may need to start and stop charging using a control on the charging equipment.

Note: The charge port lights up white when you open the charge port door. If you do not connect a charge cable, the light eventually turns off.

Note: If you do not insert the charge cable into the charge port within a few minutes after opening the charge port door, the latch closes.

If this happens, use the touchscreen to open the charge port door.

- ⚠ **Caution:** The connector end of the charge cable can damage the paint if dropped onto Model S.
- ⚠ **Caution:** Do not attempt to force the charge port door open. Doing so can damage the latch. A damaged latch cannot hold the door closed.

Plugging In

If desired, use the touchscreen to change the charge limit and the charging current.

If you are using the Mobile Connector, plug it into the power outlet before plugging it into Model S.

Align the connector to the charge port and insert fully. When the connector is properly inserted, charging begins automatically after Model S:

- Engages a latch that holds the connector in place.
- Shifts into Park (if it was in any other gear).
- Heats or cools the Battery, if needed. If the Battery requires heating or cooling, you may notice a delay before charging begins.

Note: Whenever Model S is plugged in but not actively charging, it draws energy from the wall instead of using energy stored in the Battery. For example, if you are sitting in Model S and using the touchscreen while parked and plugged in, Model S draws energy from the wall outlet instead of the Battery.



During Charging

During charging, the charge port pulses green and charging status displays on the instrument panel. The frequency at which the charge port's light pulses slows down as the charge level approaches full. When charging is complete, the light stops pulsing and is solid green.

Note: If Model S is locked, the light around the charge port does not light up.

If the light around the charge port lights up red while charging, a fault is detected. Check the instrument panel or touchscreen for a message describing the fault. A fault can occur due to something as common as a power outage. If a power outage occurs, charging resumes automatically when power is restored.

Note: When charging, particularly at high currents, the refrigerant compressor and the fan operate as needed to keep the Battery cool. Therefore, it is normal to hear sounds during charging.

Stopping Charging

You can stop charging at any time by disconnecting the charge cable or touching Stop Charging on the touchscreen.

Note: To prevent unauthorized unplugging of the charge cable, Model S must be unlocked or able to recognize a key before you can disconnect the charge cable.

To disconnect the charge cable:

1. Press and hold the button on a Tesla connector to release the latch. You can also touch Stop Charging on the charging screen (see [Changing Charge Settings](#) on page 132).
2. Pull the connector from the charge port.
3. Push the charge port door closed.

Note: If Model S is equipped with a motorized charge port door, it automatically closes when you remove the charge cable.

-  **Caution:** Tesla strongly recommends leaving Model S plugged in when not in use. This maintains the Battery at the optimum level of charge.

Charge Port Light

- **WHITE:** The charge port door is open and Model S is ready to charge. The connector either hasn't been inserted yet, or the latch is released and the connector is ready to be removed.
- **SOLID GREEN:** Charging is complete.
- **BLINKING GREEN:** Charging is in progress. As Model S approaches a full charge, the frequency of the blinking is slower.
- **BLUE:** Model S detects that a connector has been plugged in, but charging has not started. Either Model S is preparing to charge, or a charging session is scheduled to begin at a specified future time.
- **SOLID AMBER:** The connector is not fully plugged in. Realign the connector to the charge port and insert fully.
- **BLINKING AMBER:** Model S is charging at a reduced current (AC charging only).
- **RED:** A fault is detected and charging has stopped. Check the instrument panel or touchscreen for a message describing the fault.



Changing Charge Settings

The charge settings screen displays on the touchscreen whenever the charge port door is open.

To display charge settings at any time, touch the Battery icon on the top of the touchscreen, or touch Controls > Charging (located in the upper right portion of the Controls screen).

Note: The following illustration is provided for demonstration purposes only and may vary slightly depending on the software version and market region of your Model S.

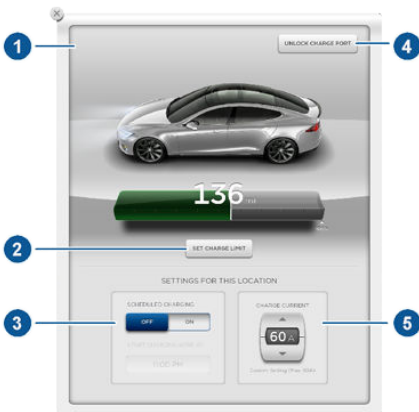

1. Charge status messages (such as Charging Scheduled, Charging In Progress) display here.
2. To adjust the charge limit, touch Set Charge Limit, then drag the slider bar. You can charge to any level from 50% to 100% based on your driving needs. The setting you choose applies to both immediate and scheduled charging sessions.

3. Location-specific schedule. With Model S in Park, set a specific time when you want Model S to begin charging at the current location. If, at the scheduled time, Model S is not plugged in at the location, it will start charging as soon as you plug it in as long as you are plugging it in within six hours of the scheduled time. If you plug in after six hours, Model S does not start charging until the scheduled time on the next day. To override this setting, touch Start Charging or Stop Charging (see item 4). When you set a scheduled charging time, Model S displays the set time on the instrument panel and the touchscreen.
4. Touch to open the charge port door or to start (or stop) charging.
5. The current automatically sets to the maximum current available from the attached charge cable, unless it was previously reduced to a lower level.

If needed, touch the up/down arrows to change the current (for example, you may want to reduce the current if you are concerned about overloading a domestic wiring circuit shared by other equipment). It is not possible to set the charging current to a level that exceeds the maximum available from the attached charge cable.

When you change the current, Model S remembers the location. So if you subsequently charge at the same location, you do not need to change it again.

Note: If Model S automatically reduced a charging location's current because of fluctuations in input power (see the note in [Charging Status](#) on page 133), Tesla recommends charging at the lower current until the underlying problem is resolved and the charging location can provide consistent power.



Charging Status

The following illustration is provided for demonstration purposes only and may vary slightly depending on the software version and market region of your Model S.

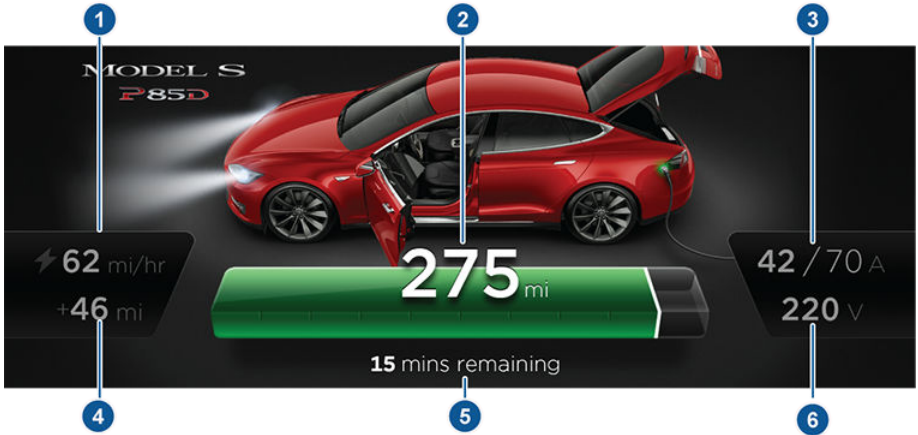

1. Charging rate per hour.
2. Total estimated driving distance (or energy) available. Instead of driving distance as shown here, you can display the percentage of battery energy remaining. To do so, touch Controls > Settings > Units & Format > Energy & Charging.
 Note: A portion of the battery image may appear blue. This indicates that a small portion of the energy stored in the battery is not available on your drive because the battery is cold. This is normal and no reason for concern. When the battery warms up, the blue portion is no longer displayed.
3. Current being supplied/Total current available from the connected power supply (see [Changing Charge Settings](#) on page 132).
4. Estimated increase in driving distance (or energy) achieved so far in this charging session. Instead of driving distance as illustrated above, you can change settings to display the amount of energy achieved. To do so, touch Controls > Settings > Units & Format > Energy & Charging.
5. Charging status information displays here. For example, if Model S is charging, it displays the time remaining until fully charged at the currently selected charge level. When scheduled charging is set for a location, it displays when charging will start.
6. Voltage being supplied by the charge cable.
 Note: If Model S is charging and detects unexpected fluctuations in the input power, it automatically reduces the charging current by 25%. For example, a 40 amp current is reduced to 30 amps. This automatic current reduction increases robustness and safety in situations when a problem exists outside of Model S or its charging electronics. For example, a home wiring system, receptacle, adapter or cord is unable to meet its rated current capacity. When Model S automatically reduces a location's charging current, it retains the reduced current for that location as a precaution. Although you can manually increase it, Tesla recommends charging at the lower current until the underlying problem is resolved and the charging location can provide consistent power.



Service Intervals

Regular maintenance is the key to ensuring the continued reliability and efficiency of your Model S.

Rotate the tires every 5000 miles (8000 km), maintain the correct tire pressures, and take Model S to Tesla at the regularly scheduled maintenance intervals of every 12 months, or every 12,500 miles (20,000 km), whichever comes first. It is also important to perform the daily and monthly checks described below.

Model S must be serviced by Tesla-certified technicians. Damages or failures caused by maintenance or repairs performed by non-Tesla certified technicians are not covered by the warranty.

Daily Checks

- Check the Battery's charge level, displayed on the instrument panel.
- Check that all exterior lights, horn, turn signals, and wipers and washers are working.
- Check the operation of the brakes, including the parking brake.
- Check the operation of the seat belts (see [Seat Belts](#) on page 19).
- Look for fluid deposits underneath Model S that might indicate a leak. It is normal for a small pool of water to form (caused by the air conditioning system's dehumidifying process).

Monthly Checks

- Check the mileage to determine if the tires need to be rotated (every 5000 miles/8000 km), and check the condition and pressure of each tire (see [Tire Care and Maintenance](#) on page 135).
- Check washer fluid level and top up if necessary (see [Topping Up Washer Fluid](#) on page 151).
- Check that the air conditioning system is operating (see [Climate Controls](#) on page 104).

 **Warning:** Contact Tesla immediately if you notice any significant or sudden drop in fluid levels or uneven tire wear.

Fluid Replacement Intervals

Do not change or top up Battery coolant and brake fluid yourself. Tesla service technicians replace fluids at the regularly scheduled service intervals:

- Brake fluid. Every 2 years or 25,000 miles (40,000 km), whichever comes first.
- Battery coolant. Every 5 years or 62,500 miles (100,000 km), whichever comes first.

Note: Any damage from opening the Battery coolant reservoir is excluded from the warranty.

High Voltage Safety

Your Model S has been designed and built with safety as a priority. However, be aware of these precautions to protect yourself from the risk of injury inherent in all high-voltage systems:

- Read and follow all instructions provided on the labels that are attached to Model S. These labels are there for your safety.
- The high voltage system has no user-serviceable parts. Do not disassemble, remove or replace high voltage components, cables or connectors. High voltage cables are colored orange for easy identification.
- If an accident occurs, do not touch any high voltage wiring, connectors, or components connected to the wiring.
- In the unlikely event that a fire occurs, immediately contact your local fire emergency responders.

 **Warning:** Always disconnect the charge cable before working underneath Model S, even if charging is not in progress.

 **Warning:** Keep your hands and clothing away from cooling fans. Some fans operate even when Model S is powered off.

 **Caution:** Some fluids (battery acid, Battery coolant, brake fluid, windshield washer additives, etc.) used in motor vehicles are poisonous and should not be inhaled, swallowed, or brought into contact with open wounds. For your safety, always read and follow instructions printed on fluid containers.



Maintaining Tire Pressures

Keep tires inflated to the pressures shown on the Tire and Loading Information label, even if it differs from the pressure printed on the tire itself. The Tire and Loading Information label is located on the center door pillar and is visible when the driver's door is open.



The Tire Pressure indicator light on the instrument panel alerts you if one or more tires is under- or over-inflated.

The Tire Pressure indicator light does not immediately turn off when you adjust tire pressure. After inflating the tire to the recommended pressure, you must drive over 25 mph (40 km/h) for more than 10 minutes to activate the Tire Pressure Monitoring System (TPMS), which turns off the Tire Pressure indicator light.

If the indicator light flashes for one minute whenever you power on Model S, a fault with the Tire Pressure Monitoring System (TPMS) is detected (see [TPMS Malfunction](#) on page 139).

Checking and Adjusting Tire Pressures

Follow these steps when tires are cold and Model S has been stationary for over three hours:

1. Remove the valve cap.
2. Firmly press an accurate tire pressure gauge onto the valve to measure pressure.
3. If required, add air to reach the recommended pressure.
4. Re-check pressure by removing and re-attaching the tire gauge.
5. If you added too much air, release air by pressing the metal stem in the center of the valve.
6. Recheck the pressure with the tire gauge and adjust if necessary.
7. Replace the valve cap to prevent dirt from entering. Periodically check the valve for damage and leaks.

⚠ Warning: Under-inflation is the most common cause of tire failures and can cause a tire to overheat, resulting in severe tire cracking, tread separation, or blowout, which causes unexpected loss of vehicle control and increased risk of injury. Under-inflation also reduces Battery range and tire tread life.

⚠ Warning: Check tire pressures using an accurate pressure gauge when tires are cold. It takes only about one mile (1.6 km) of driving to warm up the tires sufficiently to affect tire pressures. Parking the vehicle in direct sunlight or in hot weather can also affect tire pressures. If you must check warm tires, expect increased pressures. Do not let air out of warm tires in an attempt to match recommended cold tire pressures. A hot tire at or below the recommended cold tire inflation pressure is dangerously under-inflated.

⚠ Warning: Do not use any tire sealant other than the type provided in a Tesla tire repair kit. Other types can cause tire pressure sensors to malfunction. If your Model S did not include a tire repair kit, you can purchase one from Tesla.



Inspecting and Maintaining Tires

Regularly inspect the tread and side walls for any sign of distortion (bulges), cuts or wear.

⚠ Warning: Do not drive Model S if a tire is damaged, excessively worn, or inflated to an incorrect pressure. Check tires regularly for wear, and ensure there are no cuts, bulges or exposure of the ply/cord structure.

Tire Wear

Adequate tread depth is important for proper tire performance. Tires with a tread depth less than 4/32" (3 mm) are more likely to hydroplane in wet conditions and should not be used. Tires with a tread depth less than 5/32" (4 mm) do not perform well in snow and slush and should not be used when driving in winter conditions.

Model S is originally fitted with tires that have wear indicators molded into the tread pattern. When the tread has been worn down to 4/32" (3 mm), the indicators start to appear at the surface of the tread pattern, producing the effect of a continuous band of rubber across the width of the tire. For optimal performance and safety, Tesla recommends replacing tires before the wear indicators are visible.

Tire Rotation, Balance, and Wheel Alignment

Tesla recommends rotating the tires every 5000 miles (8000 km).

Unbalanced wheels (sometimes noticeable as vibration through the steering wheel) affect vehicle handling and tire life. Even with regular use, wheels can get out of balance. Therefore, they should be balanced as required.

If tire wear is uneven (on one side of the tire only) or becomes abnormally excessive, check the alignment of wheels.

Note: When replacing only two tires, always install the new tires on the rear.

Punctured Tires

A puncture eventually causes the tire to lose pressure, which is why it is important to check tire pressures frequently. Permanently repair or replace punctured or damaged tires as soon as possible.

Your tubeless tires may not leak when penetrated, provided the object remains in the tire. If, however, you feel a sudden vibration or ride disturbance while driving, or you suspect a tire is damaged, immediately reduce your speed. Drive slowly, while avoiding heavy braking or sharp steering and, when safe to do so, stop the vehicle. Arrange to have Model S transported to a Tesla, or to a nearby tire repair center.

Note: In some cases, you can temporarily repair small tire punctures (under 1/4" (6 mm)) using an optional tire repair kit available from Tesla. This allows you to slowly drive Model S to Tesla or to a nearby tire repair facility.

⚠ Warning: Do not drive with a punctured tire, even if the puncture has not caused the tire to deflate. A punctured tire can deflate suddenly at any time.

Flat Spots

If Model S is stationary for a long period in high temperatures, tires can form flat spots. When Model S is driven, these flat spots cause a vibration which gradually disappears as the tires warm up and regain their original shape.

To minimize flat spots during storage, inflate tires to the maximum pressure indicated on the tire wall. Then, before driving, release air to adjust tire pressure to the recommended levels.

Improving Tire Mileage

To improve the mileage you get from your tires, maintain tires at the recommended tire pressures, observe speed limits and advisory speeds, and avoid:

- Pulling away quickly, or hard acceleration.
- Fast turns and heavy braking.
- Potholes and objects in the road.
- Hitting curbs when parking.
- Contaminating tires with fluids that can cause damage.



Replacing Tires and Wheels

Tires degrade over time due to the effects of ultraviolet light, extreme temperatures, high loads, and environmental conditions. It is recommended that tires are replaced every six years, or sooner if required.

Wheel rims and tires are matched to suit the handling characteristics of the vehicle.

Replacement tires must comply with the original specification. If tires other than those specified are used, ensure that the load and speed ratings marked on the tire equal or exceed those of the original specification.

Ideally, you should replace all four tires at the same time. If this is not possible, replace the tires in pairs (both front or both rear). When replacing tires, always re-balance and check the alignment of wheels.

If you replace a wheel, the TPMS (Tire Pressure Monitoring System) sensors need to be reset to ensure they provide accurate warnings when tires are under- or over-inflated (see [Resetting the TPMS Sensors](#) on page 139).

⚠ Warning: For your safety, use only tires and wheels that match the original specification (see [Wheels and Tires](#) on page 169). Tires that do not match the original specification can affect the operation of the Tire Pressure Monitoring System (TPMS).

⚠ Warning: Never exceed the speed rating of your vehicle's tires. The speed rating is shown on the sidewall of your tires (see [Understanding Tire Markings](#) on page 170).

Asymmetric Tires

Model S tires are asymmetric and must be mounted on the wheel with the correct sidewall facing outward. The sidewall of the tire is marked with the word **OUTSIDE**. When new tires are installed, make sure that the tires are correctly mounted on the wheels.



⚠ Warning: Road holding is seriously impaired if the tires are incorrectly installed on the wheels.

Seasonal Tire Types

Summer Tires

Your Model S may be originally equipped with high performance summer tires. These tires are designed for maximum dry and wet road performance. Summer tires do not perform well in winter conditions. Tesla recommends using winter tires if driving in cold temperatures or on roads where snow or ice may be present. Contact Tesla for winter tire recommendations.

⚠ Warning: In cold temperatures or on snow or ice, summer tires do not provide adequate traction. Selecting and installing the appropriate tires for winter conditions is important to ensure the safety and optimum performance of your Model S, even when equipped with dual motors.

All-Season Tires

Your Model S may be originally equipped with all-season tires. These tires are designed to provide adequate traction in most conditions year-round, but may not provide the same level of traction as winter tires in snowy or icy conditions. All-season tires can be identified by "ALL SEASON" and/or "M+S" (mud and snow) on the tire sidewall.



Winter Tires

Your Model S is not originally equipped with winter tires. To increase traction in snowy or icy conditions, consider installing winter tires. When installing winter tires, always install a complete set of four tires at the same time. Winter tires must be the same size, brand, construction and tread pattern on all four wheels. Contact Tesla for winter tire recommendations.



Winter tires can be identified by a mountain/snowflake symbol on the tire's sidewall.

When driving with winter tires, you may experience more road noise, shorter tread life, and less traction on dry roads.

Driving in Low Temperatures

Tire performance is reduced in low ambient temperatures, resulting in reduced grip and an increased susceptibility to damage from impacts. Performance tires can temporarily harden when cold, causing you to hear rotational noise for the first few miles (km) until the tires warm up.

Using Tire Chains

Tesla has tested and approved Maggie Group Trak Sport P217 snow chains to increase traction in snowy conditions. These chains must only be installed on rear 19" tires. Do not use chains on 21" tires or on front tires. The approved snow chains can be purchased from Tesla.

When installing tire chains, follow the instructions provided by the tire chain manufacturer. Mount them as tightly as possible.



When using tire chains:

- Drive slowly. Do not exceed 30 mph (48 km/h).
- Avoid heavily loading Model S (heavy loads can reduce the clearance between the tires and the body).
- Remove the tire chains as soon as conditions allow.

Note: Tire chains are prohibited in some jurisdictions. Check local laws before installing tire chains.

 Caution: Using non-recommended tire chains, or using tire chains on other sized

tires, can damage the suspension, body, wheels, and/or brake lines. Damage caused by using non-recommended tire chains is not covered by the warranty.

-  Caution: Do not use chains on a Model S equipped with 21" tires and do not use tire chains on front tires.
-  Caution: Ensure that tire chains cannot touch suspension components or brake lines. If you hear the chains making unusual noises that would indicate contact with Model S, stop and investigate immediately.

Tire Pressure Monitoring

Each tire should be checked monthly when cold and inflated to the recommended pressures that are printed on the Tire and Loading Information label located on the driver's door pillar (see [Maintaining Tire Pressures](#) on page 135). If your vehicle has tires of a different size than the size indicated on the vehicle placard or tire inflation pressure label, determine the proper tire inflation pressure for those tires.

As an added safety feature, your vehicle has been equipped with a tire pressure monitoring system (TPMS) that displays a tire pressure telltale (Tire Pressure Warning) on the instrument panel when one or more of your tires is significantly under- or over-inflated. Accordingly, when the Tire Pressure indicator light displays on the instrument panel to alert you about tire pressure, stop and check your tires as soon as possible, and inflate them to the proper pressure (see [Maintaining Tire Pressures](#) on page 135). Driving on a significantly under-inflated tire causes the tire to overheat and can lead to tire failure. Under-inflation also reduces fuel efficiency and tire tread life, and may affect the vehicle's handling and stopping ability.



If Model S detects a fault with the Tire Pressure Monitoring System (TPMS), this indicator flashes for one minute whenever you power on Model S.

Note: Installing accessories that are not approved by Tesla can interfere with the TPMS.

 Warning: The TPMS is not a substitute for proper tire maintenance, including manually checking tire pressures and regularly inspecting the condition of tires.



It is the driver's responsibility to maintain correct tire pressure, even if under- or over-inflation has not reached the level for the TPMS to trigger the Tire Pressure Warning on the instrument panel.

Resetting the TPMS Sensors

After replacing one or more wheels, the TPMS sensors must be reset to ensure tire pressure warnings are accurate. However, note that the TPMS sensors do not need to be reset after replacing a tire or rotating wheels.

Note: When changing to 21" wheels (Performance Plus models), the TPMS may generate false tire pressure warnings. Bring Model S to a Tesla Service center for further adjustment.

Note: Do not reset the TPMS sensors in an attempt to clear tire pressure warnings.

To reset TPMS sensors:

1. Inflate all tires to their recommended pressures, as indicated on the Tire and Loading Information label located on the driver's door pillar.
2. Get ready to drive for ten minutes, then, on the Model S touchscreen, touch Controls > Settings > Service & Reset > Tire Pressure Monitor > Reset Sensors.
3. Follow the onscreen instructions.

Replacing a Tire Sensor

If the Tire Pressure warning indicator displays frequently, contact Tesla to determine if a tire sensor needs to be replaced. Tire sensors must be replaced by a Tesla service technician who can perform a brief setup procedure. If a non-Tesla service center repairs or replaces a tire, the tire sensor will not work until Tesla performs the setup procedure.

TPMS Malfunction

Model S has also been equipped with a TPMS malfunction indicator to indicate when the system is not operating properly.



The TPMS malfunction indicator is combined with the tire pressure indicator light. When the system detects a malfunction, the indicator flashes for approximately one minute after Model S powers on, and then remains continuously lit. This sequence continues upon subsequent vehicle start-ups as long as the malfunction exists. When the TPMS malfunction indicator is on, the system might not be able to detect or signal under- and over-inflated tires as intended.

TPMS malfunctions can occur for a variety of reasons, including installing replacement or alternate tires or wheels that prevent the TPMS from functioning properly. Always check the TPMS malfunction indicator light after replacing one or more tires or wheels on your vehicle to ensure that the replacement tires or wheels allow the TPMS to continue to function properly.

Note: If a tire has been replaced or repaired using a different tire sealant than the one available from Tesla, and a low tire pressure is detected, it is possible that the tire sensor has been damaged. Contact Tesla to have the fault repaired as soon as possible.



Tire Repair Kit



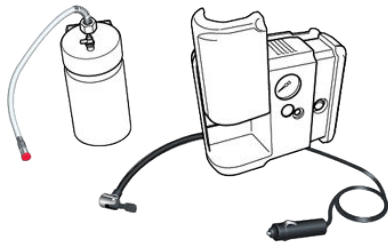

Your Model S has no spare tire. Depending on the legislations that apply to the region in which you purchased Model S, a tire repair kit may or may not be included. If a tire repair kit was not provided in Model S upon delivery, you can purchase one from Tesla.

Note: Although Model S does not have a spare tire, in the event of a flat tire, Roadside Assistance provides towing coverage for up to 50 miles.

The tire repair kit consists of a compressor and a canister of tire sealant (enough to repair one tire). When injected into a tire, the sealant can penetrate a small puncture up to 1/4" (6 mm) to form a temporary repair.







Note: For punctures larger than 1/4" (6 mm), severe tread damage, a damaged sidewall, ripped tires or tires that have come off the rim, call Roadside Assistance.

-  Warning: The tire repair kit is a temporary repair only. You must repair or replace a damaged tire as soon as possible.
-  Warning: Do not exceed 30 mph (48 km/h) when driving with a tire that has been temporarily repaired with sealant.
-  Warning: Follow all directions and warnings on the tire repair kit before starting a repair.
-  Caution: Do not drive on a deflated tire as this can cause serious damage.

Tire Sealant Canister

The tire sealant provided in the Tesla tire repair kit is approved for use with Model S and is designed not to damage the TPMS (Tire Pressure Monitoring System) sensors. Therefore, you must replace it only with one of the same type and capacity (see [Replacing the Sealant Canister](#) on page 143). Tire sealant canisters can be purchased from Tesla.

The tire sealant has an expiration date printed on the outside of the canister. If the expiration date has passed, the sealant might not work as expected. Always replace an expired tire sealant canister.

-  Warning: Do not use any tire sealant other than the one available from Tesla. Doing so could cause tire pressure sensors to malfunction.
-  Warning: Always read and follow the safety and handling instructions printed on the sealant canister.
-  Warning: Keep tire sealant out of the reach of children.
-  Warning: Tire sealant can be harmful if it contacts the eyes or if swallowed or inhaled. If the sealant comes into contact with your eyes, immediately flush with water and seek medical attention if irritation persists. If swallowed, do not induce vomiting and seek medical assistance immediately. If inhaled, breathe fresh air. Inhalation can cause drowsiness and dizziness. If breathing is affected, seek medical assistance immediately.



Inflating with Sealant and Air

If you have a Tesla tire repair kit, follow these steps to temporarily repair a small tire puncture (less than 1/4"/6 mm)).

1. Stop Model S in a safe place away from traffic and ask passengers to wait in a safe area.
2. Turn on the hazard warning flashers to alert other road users.
3. If possible, position the wheel with the puncture at the bottom.
4. Detach the power supply connector from the back of the compressor and plug it into the 12V power socket located on the front of center console.

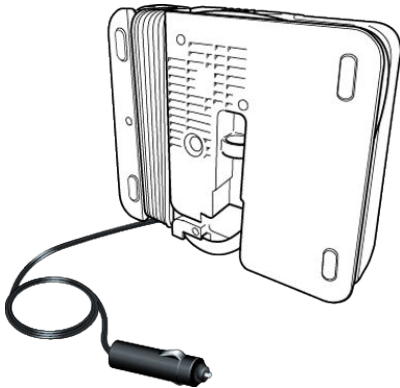

5. Release the clear plastic hose from the tire compressor.

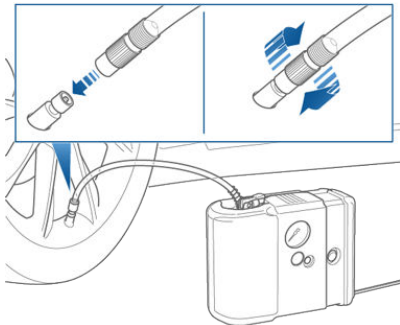

6. Remove the red cap and screw the end of the hose onto the tire's valve.

7. Attach the sealant kit's black air hose to the sealant valve and press the lever down to secure it in place.

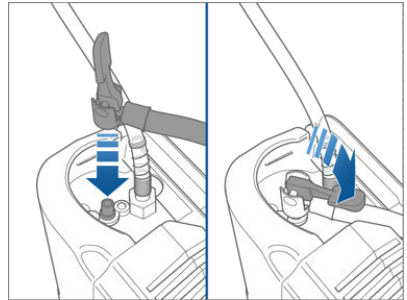

8. Ensure the compressor is lying on a level surface with the pressure gauge facing to the side as shown in Step 5.
9. Turn on the compressor.
10. Inflate the tire to the recommended pressure.
11. Turn off the compressor and disconnect the hose from the tire's valve. Wipe any excess sealant from the tire valve and wheel rim.
12. Immediately drive for 5 miles (8 km) to distribute the sealant around the tire. Do not exceed 30 mph (48 km/h).
13. Stop and check the tire's pressure. If necessary, inflate using the black air hose.
14. Have the tire repaired or replaced as soon as possible.
15. Replace the tire repair sealant canister (see [Replacing the Sealant Canister](#) on page 143).



Inflating with Air Only

If you have a Tesla tire repair kit, follow these steps to inflate a tire with air:

1. Detach the power supply connector from the rear of the compressor and plug it into the 12V power socket located in Model S on the front of center console.

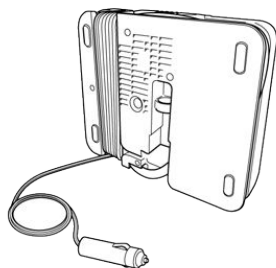

2. Release the black air hose from the compressor.
3. Attach the air hose to the valve and press the lever down to secure it in place.

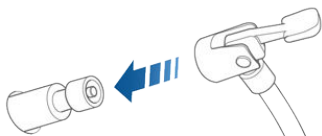

4. Ensure the compressor is lying on a level surface with the pressure gauge facing to the side where you can read it.
5. To add air, turn on the compressor and inflate until the desired pressure is reached.
6. To release air, turn off the compressor, then press and hold the red button until the desired pressure is reached.

Note: For your convenience, the tire repair kit includes a selection of adapters that allow you to inflate other items. These adapters are located in a compartment on the back of the compressor.

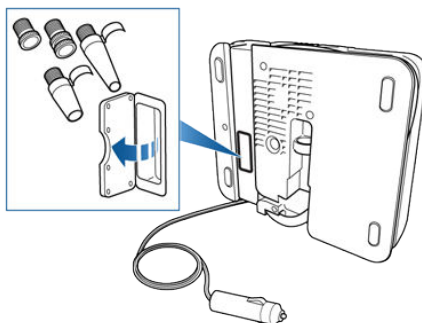

- ⚠ Caution: To avoid overheating, do not use the compressor continuously for more than eight minutes. Allow the compressor to cool for 15 minutes between uses.
- ⚠ Caution: The compressor runs slowly when overheated from excessive use. Turn it off and allow it to cool.



Replacing the Sealant Canister

If you have a Tesla tire repair kit, you can purchase additional or replacement canisters of tire sealant from Tesla.

Follow these steps to replace the canister in your Tesla tire repair kit:

1. Unwrap the clear hose from the compressor. This hose is included with the tire repair sealant canister.
2. Remove the canister cover by sliding it upward to release it from the compressor.

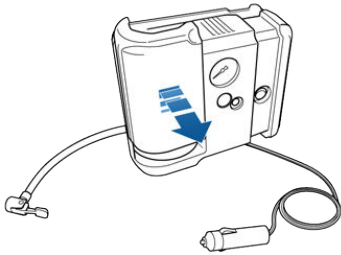

3. Remove the canister.

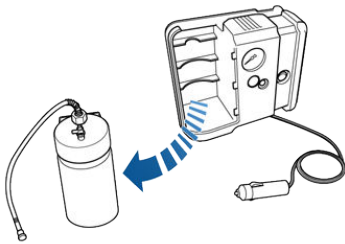

4. Insert the new canister and replace the cover.



Cleaning the Exterior

To prevent damage to the paint, immediately remove corrosive substances (bird droppings, tree resin, dead insects, tar spots, road salt, industrial fallout, etc). Do not wait until Model S is due for a complete wash. If necessary, use denatured alcohol to remove tar spots and stubborn grease stains, then immediately wash the area with water and a mild, non-detergent soap to remove the alcohol.

Follow these steps when washing the exterior of Model S:

1. Rinse Thoroughly

Before washing, flush grime and grit from the bodywork using a hose. Flush away accumulations of mud in areas where debris easily collects (such as wheel arches and panel seams). If salt has been used on the highways (such as during winter months), thoroughly rinse all traces of road salt from the underside of the vehicle.

2. Hand Wash

Hand wash Model S using a clean soft cloth and cold or lukewarm water containing a mild, good quality car shampoo.

3. Rinse with Clean Water









After washing, rinse with clean water to prevent soap from drying on the surfaces.

4. Dry Thoroughly and Clean Exterior Glass

After washing and rinsing, dry thoroughly with a chamois.

Clean windows and mirrors using an automotive glass cleaner. Do not scrape, or use any abrasive cleaning fluid on glass or mirrored surfaces.

Cautions for Exterior Cleaning

-  Caution: Do not use windshield treatment fluids. Doing so can interfere with wiper friction and cause a chattering sound.
-  Caution: Do not use hot water and detergents.
-  Caution: In hot weather, do not wash in direct sunlight.
-  Caution: If using a pressure washer, maintain a distance of at least 12" (30 cm) between the nozzle and the surface of Model S. Keep the nozzle moving and do not concentrate the water jet on any one area.
-  Caution: Do not aim water hoses directly at window, door or hood seals, or through wheel apertures onto brake components.
-  Caution: Avoid using tight-napped or rough cloths, such as washing mitts.
-  Caution: If washing in an automatic car wash, use Touchless car washes only. These car washes have no parts (brushes, etc.) that touch the surfaces of Model S. Using any other type of car wash could cause damage that is not covered by the warranty.
-  Caution: Do not use chemical based wheel cleaners. These can damage the finish on the wheels.
-  Caution: Avoid using a high pressure power washer on the rear view camera or parking sensors (if equipped) and do not clean a sensor or camera lens with a sharp or abrasive object that can scratch or damage its surface.



Cleaning the Interior

Frequently inspect and clean the interior to maintain its appearance and to prevent premature wear. If possible, immediately wipe up spills and remove marks. For general cleaning, wipe interior surfaces using a soft cloth (such as micro fiber) dampened with a mixture of warm water and mild non-detergent cleaner (test all cleaners on a concealed area before use). To avoid streaks, dry immediately with a soft lint-free cloth.

Interior Glass

Do not scrape, or use any abrasive cleaning fluid on glass or mirrored surfaces. This can damage the reflective surface of the mirror and the heating elements in the rear window.

Airbags

Do not allow any substance to enter an airbag cover. This could affect correct operation.

Dashboard and Plastic Surfaces

Do not polish the upper surfaces of the dashboard. Polished surfaces are reflective and could interfere with your driving view.

Leather Seats

Leather is prone to dye-transfer which can cause discoloration, particularly on light colored leather. White and tan leather is coated with an anti-soiling treatment. Wipe spills as soon as possible using a soft cloth moistened with warm water and non-detergent soap. Wipe gently in a circular motion. Then wipe dry using a soft, lint-free cloth. Using detergents or commercially available leather cleaners and conditioners is not recommended because they can discolor or dry out the leather.

Polyurethane Seats

Wipe spills as soon as possible using a soft cloth moistened with warm water and non-detergent soap. Wipe gently in a circular motion. After cleaning, allow the seats to air dry.

Cloth Seats

Wipe spills as soon as possible using a soft cloth moistened with warm water and non-detergent soap. Wipe gently in a circular motion. Then wipe dry using a soft, lint-free cloth. Vacuum the seats as needed to remove any loose dirt.

Carpets

Avoid over-wetting carpets. For heavily soiled areas, use a diluted upholstery cleaner.

Seat Belts

Extend the belts to wipe. Do not use any type of detergent or chemical cleaning agent. Allow the belts to dry naturally while extended, preferably away from direct sunlight.

Tesla Built-In Rear Facing Child Seats

Vacuum the seats to remove any loose dirt. Wipe the seats with a soft cloth dampened with warm water. You can also use an upholstery cleaner designed for automotive use. Extend the belts to wipe. Allow the belts to dry naturally, preferably away from direct sunlight.



Touchscreen and Instrument Panel

Clean the touchscreen and instrument panel using a soft lint-free cloth specifically designed to clean monitors and displays. Do not use cleaners (such as a glass cleaner) and do not use a wet wipe or a dry statically-charged cloth (such as a recently washed microfiber). To wipe the touchscreen without activating buttons and changing settings, you can enable clean mode. Touch Controls > Displays > Clean Mode. The display darkens to make it easy to see dust and smudges.

Chrome and Metal Surfaces

Polish, abrasive cleaners or hard cloths can damage the finish on chrome and metal surfaces.

Cautions for Interior Cleaning

-  **Warning:** If you notice any damage on an airbag or seat belt, contact Tesla immediately.
-  **Warning:** Do not allow any water, cleaners, or fabric to enter a seat belt mechanism.
-  **Caution:** Using solvents (including alcohol), bleach, citrus, naphtha, or silicone-based products or additives on interior components can cause damage.



Polishing, Touch Up, and Body Repair

To preserve the cosmetic appearance of the body, you can occasionally treat the paint surfaces with an approved polish containing:

- Very mild abrasive to remove surface contamination without removing or damaging the paint.
- Filling compounds that fill scratches and reduce their visibility.
- Wax to provide a protective coating between the paint and environmental elements.

Regularly inspect the exterior paint for damage. Treat minor chips and scratches using a paint touch-up pen (available for purchase from Tesla). Use the touch-up pen after washing but before polishing or waxing.

Repair rock chips, fractures or scratches. Body repairs should be performed only by a Tesla approved body shop. Contact Tesla for a list of approved body shops.

⚠ Caution: Do not use cutting pastes, color restoration compounds, or polishes containing harsh abrasives. These can scour the surface and permanently damage the paint.

⚠ Caution: Do not use chrome polish or other abrasive cleaners.

Using a Car Cover

To preserve the cosmetic appearance of the body when Model S is not being used, use a genuine Tesla car cover. Car covers can be purchased from Tesla.

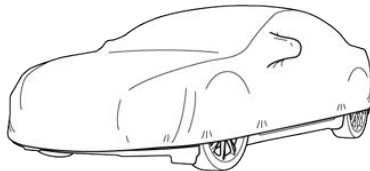

⚠ Caution: Use only a Tesla-approved car cover when Model S is plugged in. Using a non-Tesla car cover can prevent the Battery from being adequately cooled during charging.

Floor Mats

To extend the life of your carpet and make them easier to clean, use genuine Tesla floor mats. Maintain mats by regularly cleaning them and checking that they are properly attached. Replace floor mats if they become excessively worn.

⚠ Warning: To avoid potential interference with a foot pedal, ensure that the driver's floor mat is securely fastened, and never place an additional floor mat on top of it. Floor mats should always rest on top of the vehicle carpeting surface and not on another floor mat or other covering.



Checking and Replacing Wiper Blades

⚠ Caution: Wiper blades do not lock into a lifted position. When cleaning or replacing a wiper blade, lift the wiper arm only a short distance from the windshield, just far enough to access the blade. Do not lift a wiper arm beyond its intended position. Doing so can cause damage that is not covered by the warranty.

To make wiper blades easy to access, turn off the wipers, shift Model S into Park, then use the touchscreen to move them to the service position. Touch Controls > Settings > Service & Reset > Service Mode > ON.

Note: Wipers automatically return to their normal position when you shift Model S out of Park.

Periodically check and clean the edge of the wiper blade and check the rubber for cracks, splits and roughness. If damaged, replace the blade immediately to prevent damage to the glass.

Contaminants on the windshield, or on the wiper blades, can reduce the effectiveness of the wiper blades. Contaminants include ice, wax spray from car washes, washer fluid with bug and/or water repellent, bird droppings, tree sap, and other organic substances.

Follow these guidelines for cleaning:

- Clean the windshield using non-abrasive glass cleaner.
- Lift the wiper arm a short distance away from the windshield, just far enough to access the wiper blade, then wipe the blade clean using isopropyl (rubbing) alcohol or washer fluid.

If the wipers remain ineffective after cleaning, replace the wiper blades.

For optimum performance, replace wiper blades at least once a year.

To replace wiper blades:

1. Turn off the wipers, shift Model S into Park, then use the touchscreen to move the wipers to the service position. Touch Controls > Settings > Service & Reset > Service Mode > ON.

Note: Wipers must be OFF to turn on Service Mode.

2. Lift the wiper arm a short distance away from the windshield, just far enough to access the wiper blade.

3. Hold the wiper arm (the wiper arm does not lock into a lifted position) and press the locking tab while sliding the blade down the arm.
4. Align the new blade on the wiper arm and slide it toward the hooked end of the arm until it locks into place.
5. Place the wiper arm against the windshield.

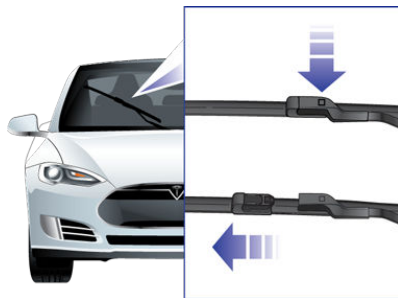

If the problem persists with new blades, clean the windshield and wiper blades by wiping with a soft cloth or sponge moistened with warm water and non-detergent soap. Then, rinse the windshield and wiper blades with clean water. The windshield is clean when water beads do not form.

⚠ Caution: Only use cleaning products approved for use on automotive glass and rubber. Inappropriate products can cause damage or smears, and create glare on the windshield.

⚠ Caution: Only install replacement blades that are identical to the original blades. Using inappropriate blades can damage the wiper system and affect the operation of the rain sensor.

Cleaning Washer Jets

The position of the windshield washers is set at the factory and should never need adjusting.

If a windshield washer becomes blocked, use a thin strand of wire to clear any blockages from the nozzle.

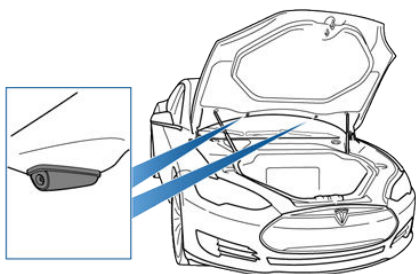

- ⚠** Warning: Do not operate the washers while cleaning Model S. Windshield washer fluid can irritate eyes and skin. Read and observe the washer fluid manufacturer's instructions.



Removing the Maintenance Panel

To access fuses and check fluid levels, remove the maintenance panel:

1. Pull the rear edge of the maintenance panel upward to release the five clips that hold the panel in place.
2. Maneuver the maintenance panel toward the windshield to remove.

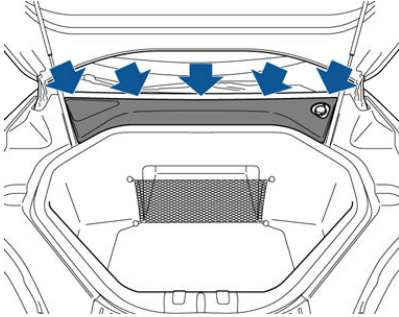

⚠ Caution: The maintenance panel protects the front trunk from water. When re-attaching, make sure it is fully seated.

Checking Battery Coolant

If the quantity of fluid in the cooling system drops below the recommended level, the instrument panel displays a warning message. Stop Model S as soon as safety permits and contact Tesla.

Fluid Level Check

Tesla checks the Battery coolant level at the regularly scheduled maintenance intervals. On a single motor Model S, you can check it yourself. To do so, park Model S on level ground. When Model S is cool, remove the maintenance panel (see [Removing the Maintenance Panel](#) on page 149).

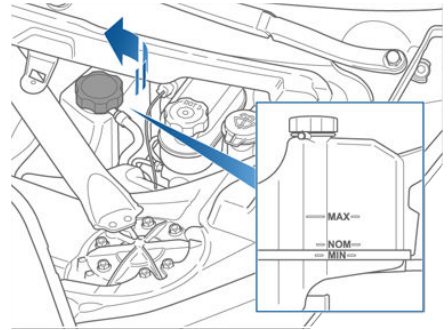

Check the fluid level visually by looking at the outside marks on the side of the reservoir. **DO NOT REMOVE THE FILLER CAP AND DO NOT ADD FLUID.** Doing so can result in damage not covered by the warranty.

The fluid level should be between the MIN and the MAX marks. If you notice that the fluid level has dropped significantly, contact Tesla before using Model S.

Topping Up the Battery Coolant

Under no circumstances should you add coolant. If the instrument panel warns you that the fluid level is low, contact Tesla immediately.

To maximize the performance and life of the Battery, the cooling system uses a specific type of G-48 ethylene-glycol coolant (HOAT). Contact Tesla for more specific information about the coolant.



Checking Brake Fluid

⚠ Warning: Contact Tesla immediately if you notice increased movement of the brake pedal or a significant loss of brake fluid. Driving under these conditions can result in extended stopping distances or complete brake failure.



The Brake indicator on the instrument panel alerts you if the quantity of fluid in the brake reservoir drops below the recommended level. If it displays while driving, stop as soon as safety permits by gently applying the brakes. Do not continue driving. Contact Tesla immediately.

Fluid Level Check

Tesla checks the brake fluid level at the regularly scheduled maintenance intervals. To check it yourself, park Model S on level ground. When Model S is cool, remove the maintenance panel (see [Removing the Maintenance Panel](#) on page 149).

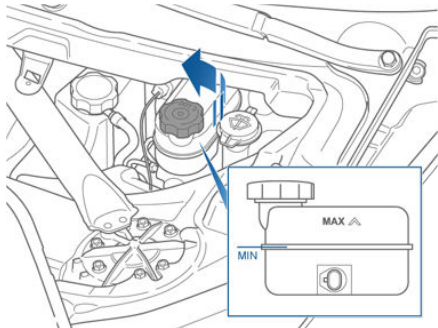

Check the fluid level visually by looking at the outside marks on the side of the reservoir without removing the filler cap.

The brake fluid level should always be between the MIN and the MAX marks.

Note: Although brake fluid level drops slightly during normal use as a result of brake pad wear, it should not drop below the MIN mark.

Topping Up the Brake Fluid

Do not top up your brake fluid. Tesla service does this when you bring Model S in for regular servicing. The following instructions are provided for information purposes and future reference only:

1. Clean the filler cap before removing to prevent dirt from entering the reservoir.
2. Unscrew the cap and remove.
3. Top up the reservoir to the MAX mark using brake fluid meeting DOT3 specifications.
4. Replace the filler cap.

⚠ Warning: Only use new fluid from a sealed air-tight container. Never use previously used fluid or fluid from a previously opened container—fluid absorbs moisture which decreases braking performance.

⚠ Warning: Brake fluid is highly toxic. Keep containers sealed and out of the reach of children. In the event of accidental consumption, seek medical attention immediately.

⚠ Caution: Brake fluid damages painted surfaces. Immediately soak up any spills with an absorbent cloth and wash the area with a mixture of car shampoo and water.



Topping Up Washer Fluid

The only reservoir into which you can add fluid is the washer fluid reservoir located under the front trunk. When the level is low, a message displays on the instrument panel.

Do not use formulated washer fluids that contain water repellent or bug wash. These fluids can cause streaking, smearing, and squeaking or other noises.

Operate the washers periodically to check that the nozzles are clear and properly directed.

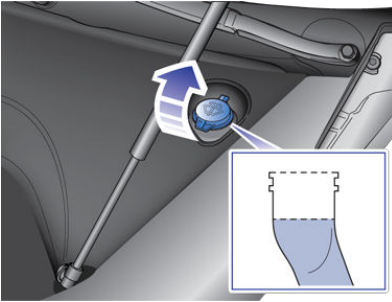

To top up washer fluid:

1. Clean the filler cap before opening to prevent dirt from entering the reservoir.
2. Open the filler cap.



3. Fill the reservoir until the fluid level is visible just below the filler neck.
4. Replace the filler cap.

Note: Some national or local regulations restrict the use of Volatile Organic Compounds (VOCs). VOCs are commonly used as antifreeze in washer fluid. Use a washer fluid with limited VOC content only if it provides adequate freeze resistance for all climates in which you drive Model S.

-  **Caution:** Under no circumstances do you need to inspect or top up other fluid reservoirs. Two additional fluid reservoirs are located next to the washer fluid, but underneath the maintenance panel. In the unlikely event that you see a message on the instrument panel that one of these fluid levels is low, stop Model S as soon as safe to do so, and contact Tesla.
-  **Caution:** Do not spill washer fluid on body panels. Doing so can cause damage. Wipe up spills immediately and wash the affected area with water.
-  **Warning:** In temperatures below 40° F (4° C), use a washer fluid with

antifreeze. In cold weather, using a washer fluid without antifreeze can impair visibility through the windshield.



Fuse Box Locations

Three fuse boxes are located under the maintenance panel, located in the front trunk. For instructions on how to remove this panel, see [Removing the Maintenance Panel](#) on page 149.

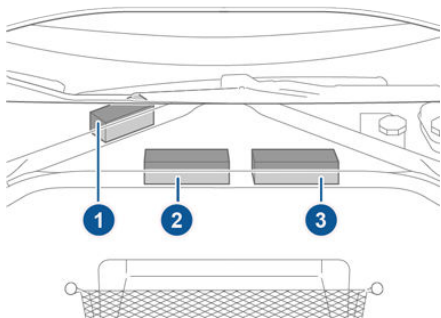

1. Fuse box 1 (see [Fuse Box 1](#) on page 153). DO NOT replace these fuses. If one of them fails, contact Tesla.
2. Fuse box 2 (see [Fuse Box 2](#) on page 155).
3. Fuse box 3 (see [Fuse Box 3](#) on page 157).

Replacing a Fuse

To remove a fuse box cover, press the plastic tabs on either side.

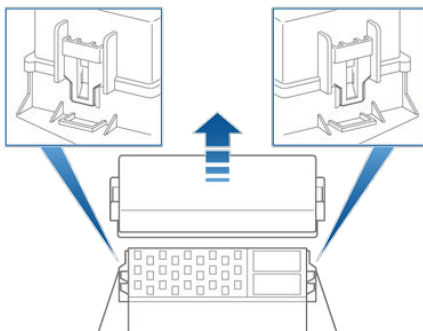

Identify the fuse protecting the affected circuit. Refer to the label on the inside of the fuse box cover or the fuse tables provided in this section.

Pull the fuse to remove it. A break in the wire inside the fuse indicates that the fuse has blown.

Note: Do not replace fuses in fuse box 1, and do not remove or replace any relays. If one of these fails, contact Tesla.

- Warning:** Always manually power Model S off before replacing a fuse (see [Powering Off](#) on page 41).
- Caution:** Only use Tesla-approved replacement fuses of the same rating and specification. Using an incorrect fuse can damage the electrical system and result in a fire.
- Caution:** If a replacement fuse blows after installation, contact Tesla to have the electrical system checked.



Fuse Box 1

Note: Access to fuse box 1 requires removal of components that must be performed by a Tesla service technician. The following fuse list is provided only to assist you in determining if a fuse in this box needs to be replaced. Contact Tesla Service if one of these fuses needs to be replaced.

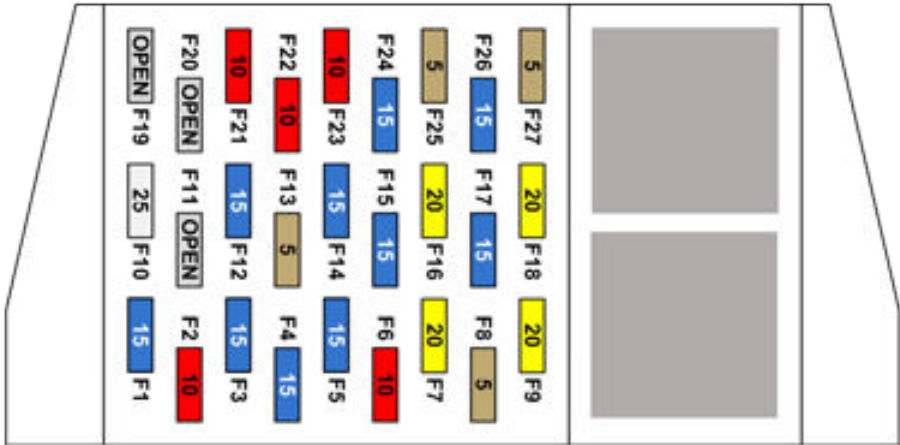

Fuse	Rating	Circuit Protected
1	15 A	Wiper (off position)
2	10 A	Headlight Leveling, Vanity Lights
3	15 A	Seat Heater, Second Row Right
4	15 A	Seat Heater, Second Row Middle
5	15 A	Seat Heater (Driver's Seat)
6	10 A	Not Used
7	20 A	Electronic Parking Brake (Redundant)
8	5 A	Steering Module Column
9	20 A	Base Audio System
10	25 A	Panoramic Sunroof
11	Open	Not Used
12	15 A	Seat Heater, Second Row Left
13	5 A	Cabin HVAC Functions
14	15 A	Seat Heater, First Row Left
15	15 A	Not Used
16	20 A	Electronic Parking Brake (Primary)
17	15 A	Coolant Pump 2



Fuse	Rating	Circuit Protected
18	20 A	Premium Audio Amplifier
19	Open	Not Used
20	Open	Not Used
21	15 A	Park Assist
22	5 A	Thermal System Controls (Main Power)
23	15 A	Not Used
24	5 A	Coolant Pump 3
25	15 A	Drive Inverter
26	15 A	Coolant Pump 1
27	10 A	SRS (Seating and Safety Restraints) Control Module



Fuse Box 2



Fuse	Rating	Circuit Protected
28	25 A	Window Lift Motor (Right Rear)
29	10 A	Contactator Power
30	25 A	Window Lift Motor (Right Front)
31	15 A	Forward Camera/Active Safety
32	10 A	Door Controls (Right Side)
33	15 A	Not Used
34	10 A	Forward Camera Defog
35	15 A	12V Power Socket
36	10 A	Air Suspension
37	25 A	Window Lift Motor (Left Rear)
38	5 A	Driver's Seat Memory
39	25 A	Window Lift Motor (Left Front)
40	5 A	Rear Door Handles
41	10 A	Door Controls (Left Side)
42	30 A	Powered Liftgate
43	5 A	Perm. Power Sensor, Brake Switch
44	10 A	Charger (Charge Port)
45	20 A	Passive Entry (Horns)
46	30 A	Body Controls (Group 2)
47	5 A	Glove Box Light, OBD-II
48	10 A	Body Controls (Group 1)



Fuse	Rating	Circuit Protected
49	5 A	Instrument Panel
50	5 A	Siren, Intrusion/Tilt Sensor (Europe Only)
51	20 A	Touchscreen
52	30 A	Heated Rear Window
53	5 A	Battery Management System
54	15 A	Wiper De-icer
55	30 A	Left Front Electric Seat
56	30 A	Right Front Electric Seat
57	30 A	Cabin Fan
58	30 A	12V Outlet/Forward Camera Subfeed
59	30 A	HVAC2 Power



Fuse Box 3

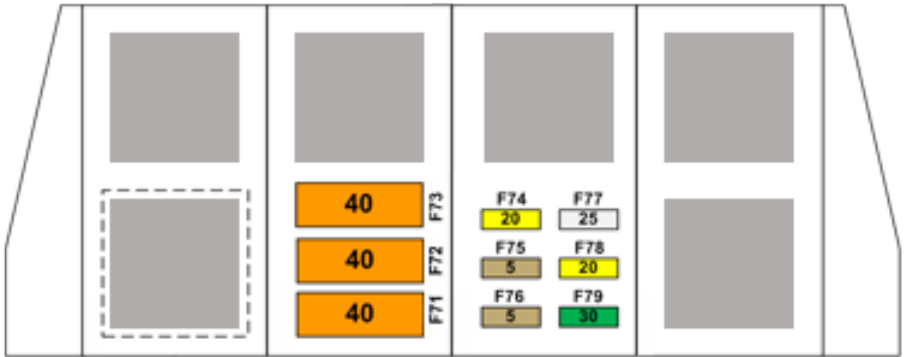

Fuse	Rating	Circuit Protected
71	40 A	Condenser Fan (Left)
72	40 A	Condenser Fan (Right)
73	40 A	Vacuum Pump
74	20 A	Key On
75	5 A	Front Drive Unit
76	5 A	Ignition Sensor
77	25 A	Stability Control
78	20 A	Headlights High/Low Beam
79	30 A	Light - Exterior/Interior



Jacking Procedure

Follow the steps below to lift Model S. Ensure that any non-Tesla repair facility is aware of these lifting points.

1. Position Model S centrally between the lift posts.
2. If your Model S is equipped with Smart Air Suspension, it automatically self-levels, even when power is off. Use the touchscreen to set the suspension as follows:
 - Touch Controls > Suspension.
 - Press the brake pedal, then touch Very High to maximize the height of the suspension.
 - Touch Jack to disable self-leveling.



When Jack mode is active, Model S displays this indicator light on the instrument panel, along with a message telling you that active suspension is disabled.

3. Position the lift arm pads under the body rails at the locations illustrated. **DO NOT** position the lift arm pads under the Battery.
4. Adjust the height and position of the lift arm pads to ensure they are correctly located.
5. With assistance, raise the lift, ensuring the lift arm pads remain in their correct positions.

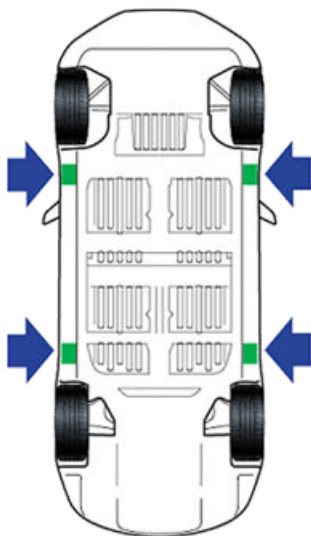

Note: Jack mode cancels when Model S is driven over 4.5 mph (7 km/h).



- Warning:** If your Model S is equipped with Smart Air Suspension, it automatically self-levels, even when power is off. You **MUST** disable this system by engaging Jack mode before lifting or jacking. If you do not disable Smart Air Suspension, Model S can attempt to self-level, causing serious damage, bodily injury, or death.
- Warning:** Never raise Model S when the charge cable is connected, even if charging is not in progress.
- Warning:** Do not work on an incorrectly supported vehicle. Doing so can cause serious damage, bodily injury, or death.
- Caution:** **DO NOT** lift from under the Battery. Place the lift arm pads under the body rails only. The locations illustrated are the only approved lifting points for Model S. Lifting at any other points can cause damage. Damage caused by lifting Model S is not covered by the warranty.



Parts, Accessories, and Modifications

Use only genuine Tesla parts and accessories. Tesla performs rigorous testing on parts to ensure their suitability, safety, and reliability. Purchase these parts from Tesla, where they are professionally installed and where you can receive expert advice about modifications to Model S.

Tesla is unable to assess parts manufactured by other distributors and therefore accepts no responsibility if you use non-Tesla parts on Model S.

-  **Warning:** Installing non-approved parts and accessories, or performing non-approved modifications, can affect the performance of Model S and the safety of its occupants. Any damage caused by using or installing non-approved parts, or by performing non-approved modifications, is not covered by the warranty.
-  **Warning:** Tesla does not accept liability for death, personal injury or damage that occurs if you use or install non-approved accessories or make non-approved modifications.

Body Repairs

If Model S is in a collision, contact Tesla to ensure that it is repaired with genuine Tesla parts. Tesla has selected and approved body shops that meet strict requirements for training, equipment, quality, and customer satisfaction.

Some repair shops and insurance companies might suggest using non-original equipment or salvaged parts to save money. However, these parts do not meet Tesla's high standards for quality, fit and corrosion resistance. In addition, non-original equipment and salvaged parts (and any damage or failures they might cause) are not covered by the warranty.



Vehicle Identification Number

You can find the VIN at the following locations:

- Touch the Tesla “T” at the top center of the touchscreen. The VIN displays on the popup window.
- Stamped on a plate located at the top of the dashboard. Can be seen by looking through the windshield.
- Stamped on the chassis. Can be seen by removing the maintenance panel (see [Removing the Maintenance Panel](#) on page 149).
- Printed on the Vehicle Certification label, located on the driver’s side door pillar. Can be seen when the driver’s door is open.

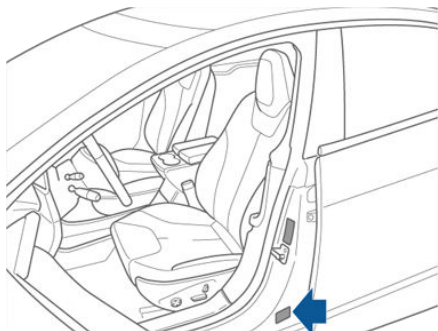

Emission Control Label

The emission control label is located on the opening face of the liftgate.





Load Capacity Labeling

It is important to understand how much weight your Model S can safely carry. This weight is called the vehicle capacity weight and includes the weight of all occupants, cargo and any additional equipment added to your Model S since it was manufactured.

There are two labels attached to Model S that state how much weight it can safely carry. These labels are located on the center door pillar and are visible when the driver's door is open:

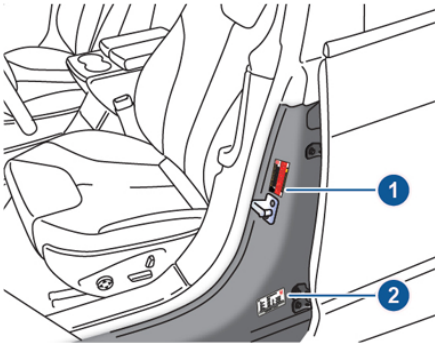

1. Tire and Loading Information label
2. Vehicle Certification label

Warning: Overloading Model S has an adverse effect on braking and handling, which can compromise your safety or damage Model S.

Caution: Never load more than 300 lbs (136 kg) in the front trunk. Doing so can cause damage.

Caution: Never store large amounts of liquid in Model S. A significant spill can cause electrical components to malfunction.

Tire and Loading Information Label

The Tire and Loading Information label provides:

- The maximum number of occupant seating positions.
- The maximum vehicle capacity weight.
- The size of the original tires.
- The cold inflation pressures for the original front and rear tires. These pressures are recommended to optimize ride and handling characteristics.

TIRE AND LOADING INFORMATION
RENSEIGNEMENTS SUR LES PNEUS ET LE CHARGEMENT

(SEATING CAPACITY/NOMBRE DE PLACES - TOTAL X FRONT/AVANT X REAR/ARRIÈRE X)
LE POIDS TOTAL DES OCCUPANTS ET DU CHARGEMENT NE DOIT JAMAIS DÉPASSER

THE COMBINED WEIGHT OF OCCUPANTS AND CARGO SHOULD NEVER EXCEED
LE POIDS TOTAL DES OCCUPANTS ET DU CHARGEMENT NE DOIT JAMAIS DÉPASSER

TIRE/PNEU	FRONT/AVANT	REAR/ARRIÈRE	SPARE/DE SECOURS
ORIGINAL TIRE SIZE/ TAILLE DES PNEUS D'ORIGINE	depends on véhicule/modèle	depends on véhicule/modèle	NONE/AUCUN
COLD TIRE PRESSURE/ PRESSION DES PNEUS À FROID	depends on véhicule/modèle	depends on véhicule/modèle	NONE/AUCUN

SEE OWNER'S MANUAL FOR ADDITIONAL INFORMATION. VOIR LE MANUEL DE L'USAGER POUR PLUS DE RENSEIGNEMENTS.

Never change this label, even if you use different tires in the future.

Note: If Model S is loaded to its full capacity, double check all tires to ensure they are inflated to their recommended pressure levels.

Vehicle Certification Label

The Vehicle Certification label provides:

- GVWR - Gross Vehicle Weight Rating. The maximum allowable total mass of Model S. This is calculated as the weight of Model S, all passengers, fluids, and cargo.
- GAWR FRT and GAWR RR - Gross Axle Weight Rating for the front and rear axles. The GAWR is the maximum distributed weight that each axle can support.

United States:

MFD BY TESLA MOTORS, INC.

GVWR	WITH TIRES		
GAWR FRT	WITH TIRES	RIM	COLD TIRE PRESSURE
GAWR RR	WITH TIRES	RIM	COLD TIRE PRESSURE

THIS VEHICLE CONFORMS TO ALL APPLICABLE U.S. FEDERAL MOTOR VEHICLE SAFETY STANDARDS IN EFFECT ON THE DATE OF MANUFACTURE SHOWN ABOVE.

Canada:

MFD BY TESLA MOTORS, INC./FABRIQUÉ PAR TESLA MOTORS, INC.

GVWR/PNEV	WITH TIRES/AVEC PNEUS		
GAWR FRT/PNEV AVT	WITH TIRES/AVEC PNEUS	RIM/JANTE	COLD TIRE PRESSURE/PRESSION DES PNEUS À FROID
GAWR RR/PNEV ARR	WITH TIRES/AVEC PNEUS	RIM/JANTE	COLD TIRE PRESSURE/PRESSION DES PNEUS À FROID

THIS VEHICLE CONFORMS TO ALL APPLICABLE STANDARDS PRESCRIBED UNDER THE CANADIAN MOTOR VEHICLE SAFETY REGULATIONS IN EFFECT ON THE DATE OF MANUFACTURE. CE VÉHICULE EST CONFORME À TOUTES LES NORMES QUI LUI SONT APPLICABLES EN VERTU DU RÈGLEMENT SUR LA SÉCURITÉ DES VÉHICULES AUTOMOBILES DU CANADA EN VIGUEUR À LA DATE DE SA FABRICATION.

Caution: To prevent damage, never load Model S so that it is heavier than GVWR or exceeds the individual GAWR weights.



Calculating Load Limits

1. Locate the statement “The combined weight of occupants and cargo should never exceed XXX kg or XXX lbs” on your vehicle’s “Tire and Loading Information” label.
2. Determine the combined weight of the driver and passengers that will be riding in the vehicle.
3. Subtract the combined weight of the driver and passengers from XXX kg or XXX lbs (see Step 1).
4. The resulting figure equals the available amount of cargo and luggage load capacity. For example, if the “XXX” amount equals 1400 lbs (635 kg) and there will be five 150 lb (68 kg) passengers in the vehicle, the amount of available cargo and luggage capacity is 650 lbs (1400 - 750 (5 x 150) = 650 lbs) or 295 kg (635 - 340 (5 x 68) = 295 kg).
5. Determine the combined weight of cargo and luggage being loaded on the vehicle. That weight must not exceed the available cargo and luggage load capacity calculated in Step 4.

⚠ Warning: The front and rear trunks are the preferred places to carry objects. In an accident, or during hard braking and sharp turns, loose items in the cabin could injure occupants.

Example Load Limit Calculations

How much cargo you can carry in Model S depends on the number and weight of passengers. The following are typical examples of calculated load limits. These examples assume passengers weighing 150 lbs (68 kg). If the passengers weigh more or less, the available cargo and luggage load capacity decreases or increases respectively.

Driver and one passenger

Description	Total
Vehicle capacity weight	954 lbs (433 kg)
Subtract occupant weight (2 x 150 lbs/68 kg)	300 lbs (136 kg)
Available cargo weight	654 lbs (297 kg)

Driver and four passengers

Description	Total
Vehicle capacity weight	954 lbs (433 kg)
Subtract occupant weight (5 x 150 lbs/68 kg)	750 lbs (340 kg)
Available cargo weight	204 lbs (93 kg)

The available cargo or luggage weight should then be distributed between the front and rear trunks.

⚠ Caution: Do not exceed the maximum front trunk load weight of 300 lbs (136 kg).

Towing a Trailer

⚠ Warning: Do not use Model S for towing purposes. Model S does not support a trailer hitch. Installing one could cause damage and increase the risk of an accident.

⚠ Caution: Using Model S for towing may void the warranty.

Roof Racks

If Model S is equipped with the all glass panoramic roof, you can carry up to 75 kg using a Tesla-approved roof rack (see [Parts and Accessories](#) on page 159). A Model S equipped with a solid aluminum roof is incompatible with roof racks.

⚠ Caution: Damage caused by roof racks is not covered by the warranty.

⚠ Caution: Do not use roof racks, or place any load, on the roof of a Model S that is equipped with a solid aluminum roof. Doing so can cause significant damage.



Exterior Dimensions

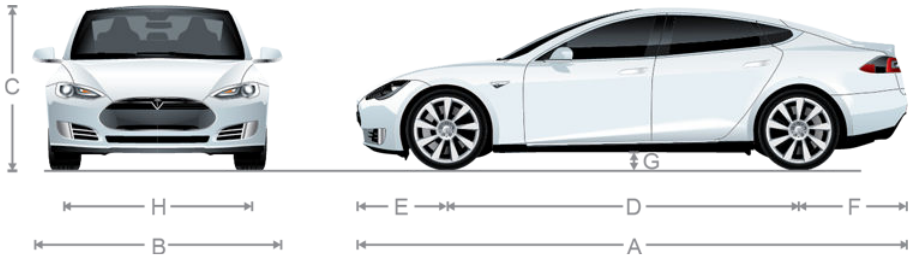

A	Overall Length	196 in	4,970 mm
B	Overall Width (including mirrors)	86.2 in	2,189 mm
	Overall Width (excluding mirrors)	77.3 in	1,964 mm
C	Overall Height	56.5 in	1,445 mm
D	Wheel Base	116.5 in	2,960 mm
E	Overhang - Front	37 in	929 mm
F	Overhang - Rear	42.5 in	1,080 mm
G	Ground Clearance - Coil Suspension	5.65 in	144 mm
G	Ground Clearance - Air Suspension	4.7 - 6.4 in	119 - 163 mm
H	Track - Front	65.4 in	1,662 mm
	Track - Rear	66.9 in	1,700 mm

Interior Dimensions

Head Room	Front	38.8 in	986 mm
	Rear	35.3 in	897 mm
Leg Room	Front	42.7 in	1,085 mm
	Rear	35.4 in	899 mm
Shoulder Room	Front	57.7 in	1,466 mm
	Rear	55 in	1,397 mm
Hip Room	Front	55 in	1,397 mm
	Rear	54.7 in	1,389 mm



Cargo Volume

Total cargo volume (single motor vehicles, rear seats not folded)	31.6 cu ft	894.85 L
Total cargo volume (dual motor vehicles, rear seats not folded)	28.8 cu ft	815.5 L
Rear cargo volume	26.3 cu ft	744.7 L
Rear cargo volume (with seats folded down)	58.1 cu ft	1645.2 L
Front cargo volume (single motor vehicles)	5.3 cu ft	150.1 L
Front cargo volume (dual motor vehicles)	2.5 cu ft	70.8 L



Weights

Curb Weight* - 60	4,407 lbs	1,999 kg
Curb Weight* - 70	4,555 lbs	2,066 kg
Curb Weight* - 70D	4,720 lbs	2,141 kg
Curb Weight* - 85/P85	4,630 lbs	2,100 kg
Curb Weight* - 85D	4,848 lbs	2,199 kg
Curb Weight* - P85D	4,963 lbs	2,251 kg
Curb Weight* - 90D	4,848 lbs	2,199 kg
Curb Weight* - P90D	4,963 lbs	2,251 kg
GVWR** - 60	5,710 lbs	2,590 kg
GVWR** - 70	5,710 lbs	2,590 kg
GVWR** - 70D	5,732 lbs	2,600 kg
GVWR** - 85/P85	5,710 lbs	2,590 kg
GVWR** - 85D	5,820 lbs	2,640 kg
GVWR** - P85D	5,886 lbs	2,670 kg
GVWR** - 90D	5,820 lbs	2,640 kg
GVWR** - P90D	5,886 lbs	2,670 kg
Gross Vehicle Weight Distribution - 19" wheels	Front: 2,425 lbs Rear: 3,285 lbs	Front: 1,100 kg Rear: 1,490 kg
Gross Vehicle Weight Distribution - 21" wheels	Front: 2,612 lbs Rear: 3,097 lbs	Front: 1,185 kg Rear: 1,405 kg
Gross Axle Weight Rating- Front	2,813 lbs	1,276 kg
Gross Axle Weight Rating- Front (Performance Plus models)	2,723 lbs	1,235 kg
Gross Axle Weight Rating - Rear: 19" wheels	3,307 lbs	1,500 kg
Gross Axle Weight Rating - Rear: 21" wheels	3,131 lbs	1,420 kg
Trailer Towing	Not permissible	
*Curb Weight = weight of the vehicle with correct fluid levels, no occupants and no cargo		
**GVWR = Gross Vehicle Weight Rating		



Motor

Type	AC induction motor, liquid-cooled, with variable frequency drive
Rating	320 Volts
Maximum speed of large motors: - rear motor on all single motor models - rear motor on P85D	16000 rpm
Maximum speed of small motors: - front motor on all dual motor models - front and rear motor on 85D	18000 rpm
Maximum net power* and engine speed of large motors	Base: 285 kW @ 6850 rpm Performance: 375 kW @ 5950 rpm
Maximum net power* and engine speed of small motors	Base: 145 kW @ 5700 rpm Performance: 193 kW @ 6100 rpm
Maximum torque of large motors	Base: 440 Nm Performance: 650 Nm
Maximum torque of small motors	Base: 250 Nm Performance: 330 Nm
*Tested in accordance with ECE R85	

Transmission

Type	Single speed fixed gear
Overall Final Drive Ratio	9.73:1
Reverse Gear	Reverse direction of motor, limited to 15 mph (24 km/h)

Steering

Type	Rack and pinion with electronic power steering Variable ratio and speed sensitive
Number of turns lock to lock	2.45
Turning Circle (curb to curb)	40.7 ft (12.4 m)



Brakes

Type	4-wheel anti-lock braking system (ABS) with Electronic Brake Force Distribution, Integrated Advanced Stability Control and Electronic Accelerator pedal actuated regenerative braking system
Calipers	Four piston fixed
Rotor Diameters (ventilated)	Front: 13.98"/355 mm Rear: 14.37"/365 mm
Front Rotor thickness	New: 1.26"/32 mm Service limit: 1.18"/30 mm
Rear Rotor thickness	New: 1.10"/28 mm Service limit: 1.02"/26 mm
Front Brake Pad Thickness (excluding back plate)	New: 0.354"/9.0 mm Service limit: 0.078"/2 mm
Rear Brake Pad Thickness (excluding back plate)	New: 0.315"/8.0 mm Service limit: 0.078"/2 mm
Electronic Parking Brake (EPB) Pad Thickness (excluding back plate). Electronic calipers self-adjust for pad wear.	New: 0.216"/5.5 mm Service limit: 0.039"/1 mm
Parking brake	Electrically actuated parking brake calipers

Suspension

Front	Independent, double wishbone, air spring or coil spring/telescopic damper, sway bar
Rear	Independent, multi-link, air spring or coil spring/telescopic damper, sway bar (air suspension vehicles only)

Battery - 12V

Rating	33 amp-hr or higher
Voltage and Polarity	12V negative (-) ground



Battery - High Voltage

Type	Liquid-cooled lithium ion (Li-ion)
Rating	60, 70, 85 or 90 kWh (at beginning of life)
Nominal Voltage - 85 and 90 kWh	346 V DC
Nominal Voltage - 40, 60, and 70 kWh	302 V DC
Temperature Range	Do not expose Model S to ambient temperatures above 140° F (60° C) or below -22° F (-30° C) for more than 24 hours at a time.



Wheel Specifications

Wheel Type	Location	Size	Offset
19"	Front	8.0J x 19	1.575" 40 mm
	Rear	8.0J x 19	1.575" 40 mm
21" - Silver (standard)	Front	8.5J x 21	1.575" 40 mm
21" - Grey (standard)	Rear	8.5J x 21	1.575" 40 mm
21" - Silver and Grey (optional) Performance Plus vehicles	Rear	9.0J x 21	1.575" 40 mm

Road Wheel Nut Torque	129 lb. ft (175 Nm)
Note: For instructions on how to jack/lift Model S, see Jacking and Lifting on page 158.	

Tire Specifications

Tire Type	Location	Size
19" wheels	All	P245/45R19
21" wheels	Front	P245/35R21
	Rear	P265/35R21*
*On a P85D and P90D Model S, the width of the rear tires may vary depending on date of manufacture. Some vehicles may be equipped with P245/35R21 tires on both front and rear.		
Tire pressures vary depending on the type of tires fitted. Refer to the tire pressures printed on the Tire and Loading Information label. This label is located on the center door pillar and is visible when the driver's door is open (see Maintaining Tire Pressures on page 135).		
Winter tires can be purchased from a Tesla store.		



Understanding Tire Markings

Laws require tire manufacturers to place standardized information on the sidewall of all tires. This information identifies and describes the fundamental characteristics of the tire. It also provides the tire identification number (TIN) for certification of safety standards, and in case of a recall.





1	Tire category. P indicates that the tire is for passenger vehicles.
2	Tire width. This 3-digit number is the width (in millimeters) of the tire from sidewall edge to sidewall edge.
3	Aspect ratio. This 2-digit number is the sidewall height as a percentage of the tread width. So, if the tread width is 205 mm, and the aspect ratio is 50, the sidewall height is 102 mm.
4	Tire construction. R indicates that the tire is of Radial ply construction.
5	Wheel diameter. This 2-digit number is the diameter of the wheel rim in inches.
6	Load index. This 2 or 3-digit number is the weight each tire can support. This number is not always shown.
7	Speed rating. When stated, indicates the maximum speed (in mph) at which the tire can be used for extended periods. Q=99 mph (160 km/h), R=106 mph (170 km/h), S=112 mph (180 km/h), T=118 mph (190 km/h), U=124 mph (200 km/h), H=130 mph (210 km/h), V=149 mph (240 km/h), W=168 mph (270 km/h), Y=186 mph (300 km/h).
8	Tire composition and materials. The number of plies in both the tread area and the sidewall area indicates how many layers of rubber coated material make up the structure of the tire. Information is also provided on the type of materials used.
9	Maximum tire load. The maximum load which can be carried by the tire.
10	Maximum permissible inflation pressure. This pressure should not be used for normal driving.
11	U.S. DOT Tire Identification Number (TIN). Begins with the letters DOT and indicates that the tire meets all federal standards. The next 2 digits/letters represent the plant code where it was manufactured, and the last 4 digits represent the week and year of manufacture. For example, the number 1712 is used to represent the 17th week of 2012. The other numbers are marketing codes used at the manufacturer's discretion. This information can be used to contact consumers if a tire defect requires a recall.
12	Treadwear grade. This number indicates the tire's wear rate. The higher the treadwear number is, the longer it should take for the tread to wear down. A tire rated at 400, for example, lasts twice as long as a tire rated at 200.
13	Traction grade. Indicates a tire's ability to stop on wet roads. A higher graded tire should allow you to stop your vehicle in a shorter distance than a tire with a lower grade. Traction is graded from highest to lowest as AA, A, B, and C.
14	Temperature grade. The tire's resistance to heat is grade A, B, or C, with A indicating the greatest resistance. This grading is provided for a correctly inflated tire, which is being used within its speed and loading limits.



Uniform Tire Quality Grading

The following information relates to the tire grading system developed by the National Highway Traffic Safety Administration (NHTSA), which grades tires by tread wear, traction and temperature performance. Tires that have deep tread, and winter tires, are exempt from these marking requirements.

Where applicable, quality grades are found on the tire's sidewall between the tread shoulder and maximum section width. For example:

- TREADWEAR 180
- TRACTION AA
- TEMPERATURE A

The quality grades are described next.

Note: In addition to the marking requirements, passenger car tires must conform to Federal Safety Requirements.

Treadwear

The treadwear grade is a comparative rating based on the wear rate of the tire when tested under controlled conditions on a specified government test course.

For example, a tire graded 150 wears one and a half times better on a government test course than a tire graded 100. The relative performance of tires depends on the actual conditions of their use, however, and can depart significantly from the norm due to variations in driving habits, service practices, road characteristics, and climate.

Traction

The traction grades, from highest to lowest, are: AA, A, B, and C. These grades represent a tire's ability to stop on wet pavement as measured under controlled conditions on test surfaces of asphalt and concrete. A tire marked C might have poor traction performance.

 **Warning:** Defective tires are dangerous. Do not drive if a tire is damaged, excessively worn, or is inflated to an incorrect pressure. The safety of the vehicle and occupants can be adversely affected. Check tires regularly for wear and to ensure there are no cuts, bulges or exposure of the ply/cord structure.

 **Warning:** The traction grade assigned to the tire is based on straight-ahead braking tests, and does not include:

acceleration, cornering, hydroplaning or peak traction characteristics.

Temperature

The temperature grades are A (the highest), B, and C, representing the tire's resistance to the generation of heat and its ability to dissipate heat when tested under controlled conditions on a specified indoor laboratory test wheel. Sustained high temperature can cause the tire to degenerate and reduce tire life, and excessive temperature can lead to sudden tire failure.

The grade C corresponds to the minimum level of performance that all passenger car tires must meet under the Federal Motor Safety Standard No. 109. Grades B and A represent levels of performance on the laboratory test wheel that exceed the minimum requirements.

 **Warning:** A tire's temperature grade is established for a tire that is properly inflated and not overloaded. Excessive speed, under-inflation, or excessive loading, either separately or in combination, can cause heat buildup and possible tire failure.



Wheels and Tires Glossary

Accessory Weight	The combined weight (in excess of those items replaced) of items available as factory installed equipment.
Bead	The inner edge of a tire that is shaped to fit to the rim and form an air tight seal. The bead is constructed of steel wires which are wrapped, or reinforced, by the ply cords.
Cold Tire Pressure	The air pressure in a tire that has been standing in excess of three hours, or driven for less than one mile.
Curb Weight	The weight of a standard vehicle, including any optional equipment fitted, and with the correct fluid levels.
Gross Vehicle Weight	The maximum permissible weight of a vehicle with driver, passengers, load, luggage, and equipment.
kPa (kilo pascal)	A metric unit used to measure pressure. One kilo pascal equals approximately 0.145 psi.
Maximum Inflation Pressure	The maximum pressure to which the tire should be inflated. This pressure is given on the tire side wall in psi (lbf/in).  Caution: This pressure marked on the tire is the maximum allowed by the tire manufacturer. It is not the pressure Tesla recommends using for Model S.
Maximum Loaded Vehicle Weight	The sum of curb weight, accessory weight, vehicle capacity weight, and production options weight.
Production Options Weight	The combined weight of options installed which weigh in excess of 3 lb more than the standard items that they replaced, and are not already considered in curb or accessory weights.
PSI (lbf/in)	Pounds per square inch (the unit used to measure tire pressure).
Recommended Tire Inflation Pressure	Tire inflation pressure, established by Tesla, which is based on the type of tires that are mounted on the vehicle at the factory. This information can be found on the Tire and Loading Information label located on the door pillar.
Rim	The metal support for a tire, or tire and tube, upon which the tire beads are seated.
Vehicle Capacity Weight	The number of seats multiplied by 150 lbs plus the rated amount of load/luggage.



Tesla Roadside Assistance is available to you, 24 hours a day, 365 days a year, for the duration of your warranty period.

To contact Roadside Assistance, call:

1-877-79TESLA (1-877-798-3752)

Advise the representative of the vehicle identification number (VIN), license plate number, mileage, your location, and the nature of the problem. The VIN is on the upper dashboard on the driver's side of your vehicle and is visible through the windshield.

Roadside Assistance covers transportation of Model S for up to 50 miles (80 km) in the event of a flat tire. However, owners are responsible for transportation expenses if the Battery is over-discharged. For a complete description of the terms and conditions of the Tesla Roadside Assistance Program, refer to the policy that was provided to you by Tesla when you purchased Model S.

It is your responsibility to provide vehicle transporters with instructions on how to transport Model S (see [Instructions for Transporters](#) on page 175).



Use a Flatbed Only

Use a flatbed trailer only, unless otherwise specified by Tesla. Do not transport Model S with the tires directly on the ground.



⚠ Caution: Damage caused by transporting is not covered by the warranty.

⚠ Caution: To transport Model S, follow the instructions exactly as described next.

Disable Self-Leveling (air suspension vehicles only)

If Model S is equipped with Smart Air Suspension, it automatically self-levels, even when power is off. To prevent damage, you must activate Jack mode to disable self-leveling:

1. Touch Controls > Suspension on the touchscreen.
2. Press the brake pedal, then touch Very High to maximize height.
3. Touch Jack.



When Jack mode is active, Model S displays this indicator light on the instrument panel, along with a message telling you that active suspension is disabled.

Note: Jack mode cancels when Model S is driven over 4.5 mph (7 km/h).

⚠ Warning: Failure to activate Jack mode on a Model S equipped with Smart Air Suspension can result in the vehicle becoming loose during transport, which may cause significant damage.

Activate Tow Mode

Model S may automatically shift into Park when it detects the driver leaving the vehicle, even if it has previously been shifted into Neutral. To keep Model S in Neutral (which disengages the parking brake), you must use the touchscreen to activate Tow mode:

1. Shift into Park.
2. Press the brake pedal, then on the touchscreen, touch Controls > Settings > Service & Reset > Tow Mode.



When Tow mode is active, Model S displays this indicator light on the instrument panel, along with a message telling you that Model S is free-rolling.

Note: Tow mode cancels when Model S is shifted into Park.

⚠ Caution: If the electrical system is not working, and you therefore cannot release the electric parking brake, attempt to quickly start the 12V battery. For instructions, call Tesla. If a situation occurs where you cannot disengage the parking brake, use tire skids or transport Model S for the shortest possible distance using wheeled dollies. Before doing so, always check the dolly manufacturer's specifications and recommended load capacity.



Connect the Towing Eye

The method used to connect the winch cable depends on whether Model S is equipped with a towing eye (located in the front trunk).

If not equipped with a towing eye:

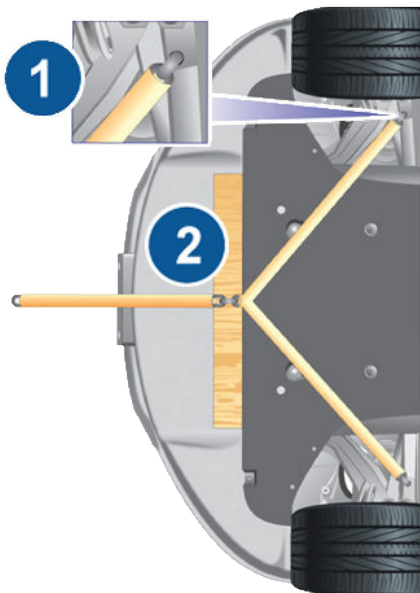

1. Attach the tow straps to the large hole on each of the rearmost lower suspension arms underneath the front of the vehicle.
2. To protect the underbody from any damage that could be caused by the tow straps, place a 2" x 4" piece of wood between the tow straps and the underbody.

⚠ Caution: Before pulling, position the wood between the tow strap and the underbody to ensure the underbody is protected from any damage that could be caused by the tow strap.

If equipped with a towing eye:

1. Locate the towing eye in the front trunk.
Pull up the carpet and remove the towing eye.

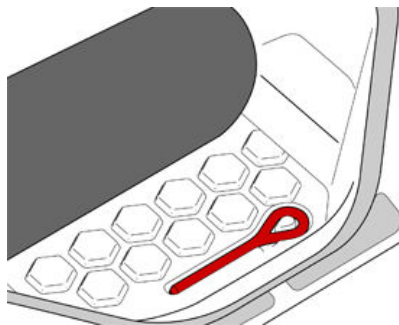

2. Remove the nose cone.

Insert a plastic pry tool into the top right corner, and gently pry the nose cone toward you. When the clip releases, pull the nose cone toward you, without twisting or bending, to release the three remaining clips.

Note: If the nose cone is equipped with a removable slot, which is distinguished by the ridge that sits directly below the slot, remove the slot by prying it from the bottom and around the edge until the entire slot is removed.

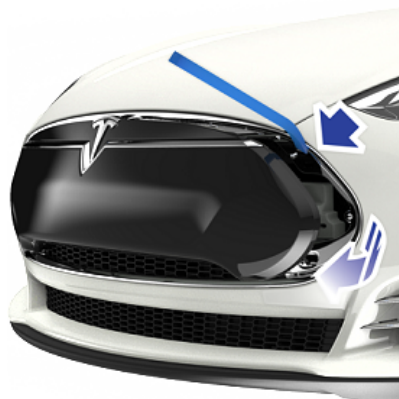



- If applicable, disconnect the bumper sensors.

If Model S is equipped with Autopilot components (see [About Driver Assistance](#) on page 65), you also need to disconnect the cords for the ultrasonic sensors. To do so, press down on the tab and pull to release.

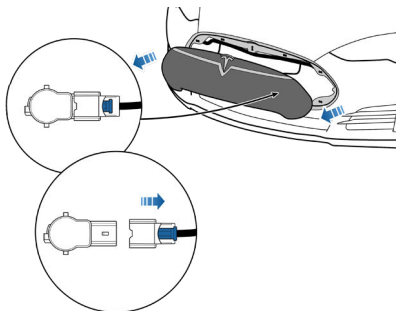

- Insert the towing eye.

Fully insert the towing eye into the opening on the right side, then turn it counter-clockwise until securely fastened.

- Attach the winch cable to the towing eye.

- ⚠ Caution:** Before pulling, make sure the towing eye is securely tightened.

Pull Onto the Trailer and Secure the Wheels

Secure wheels using the eight-point tie-down method with basket straps or tie-down straps:

- Ensure any metal parts on the tie-down straps do not contact painted surfaces or the face of the wheels.
- Do not place tie-down straps over body panels or through the wheels.

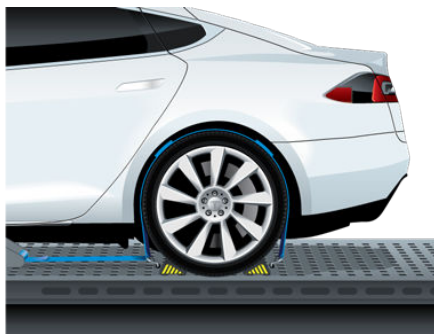

- ⚠ Caution:** Attaching tie-down straps to the chassis, suspension or other parts of the vehicle's body may cause damage.

- ⚠ Caution:** To prevent damage, do not transport Model S with the tires directly on the ground.



Illustrations

Illustrations are provided for demonstration purposes only. Depending on vehicle options, software version, region of purchase, and specific vehicle settings, your Model S may appear slightly different.

Although the owner information is applicable to both right-hand drive and left-hand drive vehicles, many illustrations show only left-hand drive vehicles. However, the essential information that the illustrations are providing is correct.

Errors or Inaccuracies

All specifications and descriptions are known to be accurate at time of publishing. However, because continuous improvement is a goal at Tesla, we reserve the right to make product modifications at any time. To communicate any inaccuracies or omissions, or to provide general feedback or suggestions regarding the quality of this owner information, send an email to:

ownersmanualfeedback@teslamotors.com

Location of Components

The owner information may specify the location of a component as being on the left or right side of the vehicle. As shown here, left (1) and right (2) represent the side of the vehicle when sitting inside Model S in a front-facing seat.

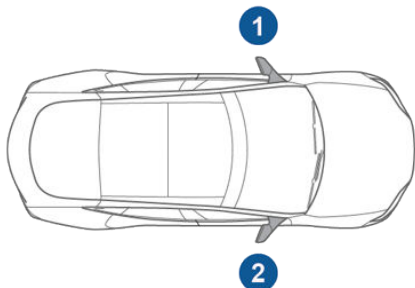

Document Applicability

Owner information is updated on a regular basis to reflect updates to your Model S. However, in some cases, recently released features may not be described. To display information about recently released features, view the Release Notes on the Model S touchscreen. Release Notes are displayed on the touchscreen after a software update, and can be displayed at any time by touching the Tesla "T" at the top center of the touchscreen, then touching the Release Notes link. If information related to how to use the Model S touchscreen conflicts with information in the Release Notes, the Release Notes take precedence.



Copyrights and Trademarks

All information in this document and all Model S¹ software is subject to copyright and other intellectual property rights of Tesla Motors, Inc. and its licensors. This material may not be modified, reproduced or copied, in whole or in part, without the prior written permission of Tesla Motors, Inc. and its licensors. Additional information is available upon request. Tesla uses software created by the Open Source community. Please visit Tesla's Open Source software website at <http://www.teslamotors.com/opensource>. The following are trademarks or registered trademarks of Tesla Motors, Inc. in the United States and other countries:

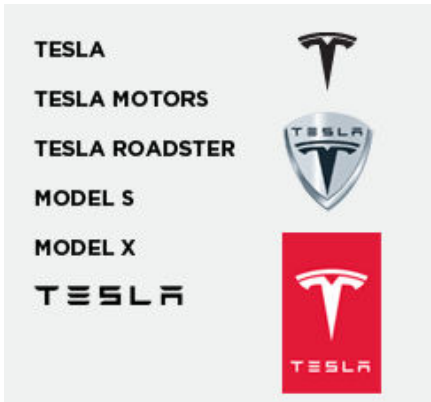

All other trademarks contained in this document are the property of their respective owners and their use herein does not imply sponsorship or endorsement of their products or services. The unauthorized use of any trademark displayed in this document or on the vehicle is strictly prohibited.



Vehicle Telematics/Data Recorders

This vehicle is equipped with electronic modules that monitor and record data from various vehicle systems, including the motor, Battery, braking and electrical systems. The electronic modules record information about various driving and vehicle conditions, including braking, acceleration, trip and other related information regarding your vehicle. These modules also record information about the vehicle's features such as charging events and status, the enabling/disabling of various systems, diagnostic trouble codes, VIN, speed, direction and location.

The data is stored by the vehicle and may be accessed, used and stored by Tesla service technicians during vehicle servicing or periodically transmitted to Tesla wirelessly through the vehicle's telematics system. This data may be used by Tesla for various purposes, including, but not limited to: providing you with Tesla telematics services; troubleshooting; evaluation of your vehicle's quality, functionality and performance; analysis and research by Tesla and its partners for the improvement and design of our vehicles and systems; and as otherwise may be required by law. In servicing your vehicle, we can potentially resolve issues remotely simply by reviewing your vehicle's data log.

Tesla's telematics system wirelessly transmits vehicle information to Tesla on a periodic basis. The data is used as described above and helps ensure the proper maintenance of your vehicle. Additional Model S features may use your vehicle's telematics system and the information provided, including features such as charging reminders, software updates, and remote access to, and control of, various systems of your vehicle.

Tesla does not disclose the data recorded in your vehicle to any third party except when:

- An agreement or consent from the vehicle's owner (or the leasing company for a leased vehicle) is obtained.
- Officially requested by the police or other authorities.
- Used as a defense for Tesla in a lawsuit.
- Ordered by a court of law.
- Used for research purposes without disclosing details of the vehicle owner or identification information.
- Disclosed to a Tesla affiliated company, including their successors or assigns, or our information systems and data management providers.



In addition, Tesla does not disclose the data recorded to an owner unless it pertains to a non-warranty repair service and in this case, will disclose only the data that is related to the repair.

Quality Control

You might notice a few miles/km on the odometer when you take delivery of your Model S. This is a result of a comprehensive testing process that ensures the quality of your Model S.

The testing process includes extensive inspections during and after production. The final inspection takes place at Tesla Motors and includes a road test conducted by a technician.

California Proposition 65

-  Warning: Certain vehicle components contain or emit chemicals known to the State of California to cause cancer and birth defects or other reproductive harm. In addition, certain fluids contained in vehicles and certain products of component wear contain or emit chemicals known to the State of California to cause cancer and birth defects or other reproductive harm.
-  Warning: Certain components of this vehicle such as airbag modules and seat belt pre-tensioners may contain Perchlorate Material. Special handling may be required for service or vehicle end of life disposal. See www.dtsc.ca.gov/hazardouswaste/perchlorate.
-  Warning: Battery posts, terminals, and related accessories contain lead and lead compounds. Wash hands after handling.



Contacting Tesla

For detailed information about your Model S, go to www.teslamotors.com, click the MY TESLA link, then enter your login credentials (or sign up to get these credentials).

If you have any questions or concerns about your Model S, call 1-877-79TESLA (1-877-798-3752).

Note: You can also use voice commands to provide feedback to Tesla. Say "Note", "Report", "Bug note", or "Bug report" followed by your brief comments. Model S takes a snapshot of its systems, including screen captures of the touchscreen and instrument panel. Tesla periodically reviews these notes and uses them to continue improving Model S. For details, see the owner's manual topic called [Using Voice Commands](#) on page 39.

Reporting Safety Defects - US

If you believe that Model S has a defect which could cause a crash or could cause injury or death, you should immediately inform the National Highway Traffic Safety Administration (NHTSA) in addition to notifying Tesla Motors.

If NHTSA receives similar complaints, it may open an investigation. If it finds that a safety defect exists in a group of vehicles, it may order a recall and remedy campaign. However, NHTSA cannot become involved in individual problems between you, your dealer, or Tesla Motors.

To contact NHTSA, you may call the Vehicle Safety Hotline toll-free at 1-888-327-4236 (TTY: 1-800-424-9153); go to www.safercar.gov; or write to: Administrator, National Highway Traffic Safety, 1200 New Jersey Avenue SE., Washington, DC 20590. You can also obtain other information about motor vehicle safety from www.safercar.gov.

Reporting Safety Defects - Canada

If you believe that your Model S has a defect which could cause a crash or could cause injury or death, you should immediately inform Transport Canada, in addition to notifying Tesla. To contact Transport Canada, call their toll-free number: 1-800-333-0510.



Key and Passive Unlocking System

FCC Certification

Model Number	Mfr	MHz	Tested For
A-0749G02	Pektron	315	USA Canada

The devices listed above comply with Part 15 of the FCC rules. Operation is subject to the following two conditions:

1. This device may not cause harmful interference, and
2. This device must accept any interference received, including interference that may cause undesired operation.

Changes or modifications not expressly approved by Tesla could void the user's authority to operate the equipment.

IC Certification

The following device is used in vehicles in Canada:

- Keyfob Model Number: A-0749G02 (315 MHz)
- Keyfob Manufacturer: Pektron

Per IC 10176A-002, this device complies with Industry Canada licence-exempt RSS standard(s). Operation is subject to the following two conditions:

1. This device may not cause harmful interference, and
2. This device must accept any interference received, including interference that may cause undesired operation.

MIC Certification

Model Number	Mfr	MHz	Tested For
A-0749G04	Pektron	315	Japan

CE Certification

Model #	Mfr	MHz	Tested For
A-0749G01	Pektron	433	Europe Australia New Zealand Singapore Taiwan Malaysia
A-0749G05	Pektron	433	China Hong Kong

The devices listed above comply with CE standards. Operation is subject to the following two conditions:

1. This device may not cause harmful interference, and
2. This device must accept any interference received, including interference that may cause undesired operation.

Changes or modifications not expressly approved by Tesla could void the user's authority to operate the equipment.

NCC Certification

- Keyfob Model Numbers: A-0749G01 (433 MHz)
- Keyfob Manufacturer: Pektron

According to NCC low-power radio wave radiation rate of motor management measures:

Article XII of the type certified by the low power radio, non-licensed, company, firm or user is not allowed to change the frequency, increase the power or change the characteristics of the original design and function.

Article XIV: The use of low-power radio-frequency devices shall not influence aircraft security and interfere with legal communications; interference phenomenon discovered over time, should be immediately suspended, and improved to no interference before use can continue. Legal communications, referring to the provisions of the Telecommunications Act of radio communications operations. Low-power radio communications shall tolerate radio wave interference from radiated devices, legal or industrial, scientific and medical.

The tire pressure monitoring system (TPMS) complies with Part 15 of the FCC rules and RSS-210 of Industry Canada. Operation is subject to the following two conditions:

1. This device may not cause harmful interference, and
2. This device must accept any interference received, including interference that may cause undesired operation.

Changes or modifications not expressly approved by Tesla could void the user's authority to operate the equipment.

Device Approval - Australia



Device Approval - Hong Kong



Device Approval - Japan



Media Control Unit

Device Approval - Japan

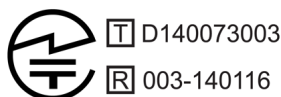

Device Approval - Australia



Tire Pressure Monitoring System

FCC IDs: TZSTPMS201, Z9F-201FS43X

IC ID: 11852A-201FS4X



HomeLink

This device complies with Part 15 of the FCC rules and IC-RSS-210 Industry Canada.

Operation is subject to the following conditions:

- This device may not cause harmful interference.
- This device must accept any interference received, including interference that may cause undesired operation.

Any changes or modifications to the device not expressly approved by the manufacturer or Tesla Motors could void the user's authority to operate the equipment.

Radio Frequency Information

This equipment has been tested and found to comply with the limits for a Class B digital device, pursuant to Part 15 of the FCC Rules.

These limits are designed to provide reasonable protection against harmful interference in a residential installation. This equipment generates, uses and can radiate radio frequency energy and, if not installed and used in accordance with the instructions, may cause harmful interference to radio communications. However, there is no guarantee that interference will not occur in a particular installation. If this equipment does cause harmful interference to radio or television reception, which can be determined by turning the equipment off and on, the user is encouraged to try to correct the interference by one or more of the following measures:

- Reorient or relocate the receiving antenna.
- Increase the separation between the equipment and receiver.
- Connect the equipment into an outlet on a circuit different from that to which the receiver is connected.
- Consult the dealer or an experienced radio/TV technician for help.



A

- ABS (Anti-lock Braking System) [54](#)
- Acceleration (dual motor) [94](#)
- access panel, removing [149](#)
- accessories
 - installing [159](#)
 - plugging into power socket [113](#)
- air circulation [105](#)
- air conditioning [104](#)
- air distribution [105](#)
- air filter [107](#)
- air suspension [109](#)
- air vents [107](#)
- airbags [31](#)
- alarm [121](#)
- all-season tires [137](#)
- always connected, setting [62](#)
- anti-lock braking (ABS) [54](#)
- audio
 - playing files [110](#)
 - steering wheel buttons [37](#)
 - volume control [110](#)
- Auto High Beam [51](#)
- Auto Lane Change [77](#)
- auto-raising suspension [108](#)
- automatic emergency braking [85](#)
- Autopark [79](#)
- Autopilot [65](#)
- Autosteer [74](#)

B

- backup camera [64](#)
- battery (12V)
 - complete discharge [129](#)
 - specifications [167](#)
- Battery (high voltage)
 - care of [129](#)
 - coolant [149](#)
 - specifications [168](#)
 - temperature limits [129](#)
- battery (key), replacing [5](#)
- blind spot warning [83](#)
- Bluetooth
 - devices, playing audio files from [112](#)
 - general information [114](#)
 - phone, pairing and using [114](#)
- body repairs [159](#)
- body touch up [146](#)
- brake fluid replacement [134](#)
- brakes
 - automatic in emergencies [85](#)
 - fluid level [150](#)
 - overview of [54](#)
 - specifications [167](#)
- brightness of displays [99](#)

C

- cabin temperature control [104](#)
- calendar [119](#)
- California Proposition 65 [180](#)
- camera (rear view) [64](#)
- car cover [146](#)
- car washes [144](#)
- cargo volume [164](#)
- carpets, cleaning [145](#)
- CE certifications [182](#)
- CHAdEMO [128](#)
- chains [138](#)
- change of ownership [103](#)
- charge port [130](#)
- charge port light [131](#)
- charging
 - charge settings [132](#)
 - components and equipment [127](#)
 - instructions [130](#)
 - public charging stations [128](#)
 - scheduling [132](#)
 - status of [133](#)
- child protection
 - disabling liftgate and rear door handles [7](#)
 - disabling rear window switches [9](#)
- child seats
 - cleaning [145](#)
 - installing and using [22](#)
 - Tesla built-in rear facing [27](#)
- cleaning [144](#)
- climate controls [104](#)
- climate ionizer [99](#)
- clock [37](#)
- Cold Weather controls [94](#)
- collision avoidance assist [85](#)
- console
 - 12V power socket [113](#)
 - cup holders [16](#)
 - USB ports [113](#)
- contact information
 - roadside assistance [174](#)
 - Tesla [181](#)
- coolant
 - Battery, checking level of [149](#)
 - Battery, replacement interval [134](#)
- copyrights [178, 179](#)
- Creep [94](#)
- cruise control [68](#)
- cup holders [16](#)
- customizing [99](#)

D

- dashboard overview [2](#)
- data recording [180](#)
- day mode [99](#)
- declarations of conformity [182](#)



- delivery mileage [180](#)
- devices
 - Bluetooth, playing audio files [112](#)
 - connecting [113](#)
 - playing audio files from [112](#)
- dimensions [163](#)
- display brightness [99](#)
- dome (map) lights [48](#)
- door handles [6](#)
- door labels [161](#)
- Door Unlock Mode [7](#)
- doors [4](#)
- doors, opening [4](#)
- Drive gear [42](#)
- drive-away locking [7](#)
- driver
 - profiles [35](#)
 - seat adjustment [17](#)
- driver assistance
 - Auto Lane Change [77](#)
 - automatic emergency braking [85](#)
 - Autopark [79](#)
 - Autosteer [74](#)
 - blind spot warning [83](#)
 - collision avoidance assist [85](#)
 - forward collision warning [85](#)
 - overtake acceleration [68](#)
 - overview [65](#)
 - settings for [99](#)
 - side collision avoidance [83](#)
 - side collision warning [83](#)
 - staying inside lane markings [83](#)
 - Traffic-Aware Cruise Control [68](#)
- driving
 - seating position [17](#)
 - starting [41](#)
 - tips to maximize range [62](#)

E

- electric parking brake [55](#)
- emergency flashers [52](#)
- emergency rear door opening [8](#)
- emission label [160](#)
- energy
 - gained from regenerative braking [55](#)
 - range information [43](#), [46](#)
 - tips to minimize usage of [62](#)
- energy & charging setting [99](#)
- energy app [62](#)
- energy saving mode [62](#)
- Erase & Reset [103](#)
- event data recording [180](#)
- exterior
 - car cover [146](#)
 - cleaning [144](#)
 - dimensions [163](#)
 - lights [48](#)

- exterior (continued)
 - overview [3](#)
 - polishing, touch up, & repair [146](#)

F

- factory defaults, restoring [103](#)
- factory reset [103](#)
- fan speed, interior [105](#)
- favorites, adding and removing [112](#)
- FCC certifications [182](#)
- features, downloading new [125](#)
- firmware (software) updates [125](#)
- flash drives, playing audio files from [112](#)
- flashers, warning [52](#)
- flat tire repair [140](#)
- floor mats [146](#)
- fluids
 - replacement intervals [134](#)
 - reservoirs, checking [149](#)
- fog lights [48](#)
- forward collision warning [85](#)
- front passenger detection [33](#)
- front trunk [12](#)
- fuses
 - location of [152](#)
 - removing access panel [149](#)

G

- garage doors, opening [122](#)
- gates, opening [122](#)
- GAWR [161](#)
- gears [42](#)
- glove box [14](#)
- Gross Axle Weight Rating [161](#)
- Gross Vehicle Weight Rating [161](#)
- ground clearance [163](#)
- GVWR [161](#)

H

- hazard warning flashers [52](#)
- head supports [18](#)
- headlights
 - after exit [51](#)
 - high beams [51](#)
- heated wipers [53](#)
- heating [104](#)
- height adjustments (suspension)
 - auto-raising [108](#)
 - automatic and manual settings [109](#)
 - disabling (Jack mode) [109](#)
- high beam headlights [51](#)
- high voltage
 - Battery specifications [168](#)



high voltage (continued)
 components 127
 safety 134
 hills, stopping on 59
 hitches 162
 HomeLink
 FCC certification 184
 programming and using 122
 hood 12
 horn 39

I

IC certifications 182
 Ideal range 99
 identification labels 160
 Insane setting (dual motor) 94
 instrument panel
 charging status 133
 cleaning 145
 overview of 43, 46
 interior
 cleaning 145
 dimensions 163
 lights 48
 overview 2
 temperature control 104
 Internet radio 111
 intrusion detection 121
 ionizer 99

J

J1772 128
 Jack mode 109
 jacking 158

K

key
 FCC and IC certifications 182
 how to use 4
 key not inside 41
 ordering extras 5
 replacing battery 5
 keyless entry 4

L

label
 Tire and Loading Information 161
 vehicle certification 161
 lane assist 83
 lane change flash 52
 lane change, automatic 77

lane departure warning 83
 language setting 99
 LATCH child seats, installing 25
 Launch Mode 60
 liftgate
 adjust opening height 10
 opening 10
 lifting 158
 lights
 hazard warning 52
 headlights after exit 51
 turn signals 51
 load limits 161
 location-based suspension 108
 locking and unlocking doors 4
 lumbar support 17

M

maintenance
 brake fluid, checking 150
 cleaning 144
 daily and monthly checks 134
 fluid replacement intervals 134
 panel, removing 149
 replacing fuses 152
 replacing washer blades 147
 service intervals 134
 tires 135
 washer fluid, topping up 151
 washer jets, cleaning 147
 maps 116
 mats 146
 media 110
 mileage upon delivery 180
 mirrors 40
 mobile app 126
 Mobile Connector
 description 128
 using 130
 modifications 159
 motor specifications 166

N

naming 102
 navigation 116
 NCC certifications 182
 Neutral gear 42
 NHTSA, contacting 181
 night mode 99
 nose cone, removing 176

O

occupancy sensor 33



odometer
 resetting trip odometer [61](#)
outside temperature [37](#)
overhang dimensions [163](#)
overtake acceleration [68](#)
Owner Information, about [178](#), [179](#)

P

Park Assist [57](#)
Park gear [42](#)
parking brake [55](#)
parking, automatic [79](#)
parts replacement [159](#)
passenger detection [33](#)
passenger front airbag [33](#)
personal data, erasing [103](#)
phone
 steering wheel controls for [38](#)
 using [114](#)
PIN [35](#)
power management [62](#)
power socket [113](#)
power windows [9](#)
powering on and off [41](#)
Preconditioning [99](#)
preferences, setting [99](#)
Proposition 65 [180](#)
public charging stations [128](#)

R

radar [65](#)
radio [110](#)
Radio Frequency information [182](#)
radio frequency, FCC information [184](#)
rain sensor [53](#)
range
 displayed on instrument panel [43](#), [46](#)
 driving tips to maximize [62](#)
 regenerative braking [55](#)
range assurance [62](#)
range mode [62](#)
Range Mode [94](#)
Rated range [99](#)
rear seats, folding and raising [18](#)
rear view camera [64](#)
rear window switches, disabling [9](#)
regenerative braking [55](#)
region format [99](#)
release notes [125](#)
Reverse gear [42](#)
roadside assistance [174](#)
roof racks [162](#)
rotating tires [136](#)
route overview [116](#)

S

safety defects
 reporting (Canada) [181](#)
 reporting (U.S.) [181](#)
safety defects, reporting [181](#)
safety information
 airbags [34](#)
 child seats [26](#)
 rear facing child seats [30](#)
 seat belts [20](#)
seat belts
 cleaning [145](#)
 in a collision [20](#)
 overview of [19](#)
 pre-tensioners [20](#)
 wearing when pregnant [19](#)
seat covers [18](#)
seat heaters [104](#)
seating capacity [161](#)
seats
 adjusting [17](#)
 heaters [104](#)
 Tesla built-in rear facing [27](#)
security settings [121](#)
self parking and unparking [79](#)
sensors [65](#)
service data recording [180](#)
service intervals [134](#)
Settings [99](#)
Settings, erasing [103](#)
shifting gears [42](#)
side collision avoidance [83](#)
side collision warning [83](#)
Slacker [111](#)
slip start [56](#)
Smart Preconditioning [99](#)
software reset [103](#)
software updates [125](#)
specifications
 cargo volume [164](#)
 dimensions [163](#)
 exterior [163](#)
 interior [163](#)
 motor [166](#)
 subsystems [166](#)
 tires [169](#)
 weights [165](#)
 wheels [169](#)
stability control [56](#)
starting [41](#)
steering specifications [166](#)
steering wheel [37](#)
steering, automatic [74](#)
summer tires [137](#)
Summon [79](#)
sunroof [15](#)
suspension [109](#)
suspension specifications [167](#)



T

telematics [180](#)

telephone
steering wheel controls for [38](#)
using [114](#)

temperature
Battery (high voltage), limits [129](#)
cabin, controls for [104](#)
outside [37](#), [43](#)
tires [172](#)

tie-down straps [177](#)

tilt detection [121](#)

Tire and Loading Information label [161](#)

tire noise [138](#)

Tire Pressure Monitoring System
FCC certification [183](#)
overview of [138](#)

tire pressures, checking [135](#)

tire repair kit
inflating with air only [142](#)
inflating with sealant [141](#)
replacing the sealant canister [143](#)

tires
all-season [137](#)
balancing [136](#)
chains [138](#)
industry glossary of terms [173](#)
inspecting and maintaining [136](#)
pressures, how to check [135](#)
quality grading [172](#)
replacing [137](#)
replacing a tire sensor [139](#)
rotation [136](#)
specification [169](#)
summer [137](#)
temperature grades [172](#)
tire markings [170](#)
tire sealant [140](#)
traction grade [172](#)
treadwear grade [172](#)
winter [138](#)

torque specifications [166](#)

touch up body [146](#)

touchscreen
clean mode [145](#)
cleaning [145](#)
Controls [94](#)
overview [90](#)
Settings [99](#)
software updates [125](#)

Tow mode [175](#)

towing [175](#)

towing a trailer [162](#)

towing eye, locating [176](#)

towing instructions [175](#)

TPMS
FCC certification [183](#)
overview of [138](#)

traction control [56](#)

trademarks [178](#), [179](#)

traffic alerts [112](#)

Traffic-Aware Cruise Control [68](#)

trailer hitches [162](#)

transmission specifications [166](#)

Transport Canada, contacting [181](#)

transporting [175](#)

trip chart [62](#)

trip information [61](#)

trip overview [116](#)

trip planner [116](#)

trunk, front [12](#)

trunk, rear
child protection lock [7](#)
disabling interior handle [7](#)

TuneIn [111](#)

turn signals [51](#)

U

ultrasonic sensors [65](#)

uniform tire quality grading [172](#)

Units & Format [99](#)

Unlock on Park [4](#)

unlocking
trunk, front [12](#)
trunk, rear [10](#)

unlocking and locking doors [4](#)

unlocking when key doesn't work [7](#)

USB devices
connecting [113](#)
playing audio files from [112](#)

USB ports [113](#)

V

Valet Mode [35](#)

vehicle certification label [161](#)

Vehicle Hold [59](#)

Vehicle Identification Number (VIN) [160](#)

vehicle loading [161](#)

vent, sunroof [15](#)

ventilation [107](#)

VIN (Vehicle Identification Number) [160](#)

volume control [90](#)

volume control (media) [110](#)

W

walk-away locking [7](#)

Wall Connector [128](#)

warning flashers [52](#)

washer fluid, topping up [151](#)

washer jets, cleaning [147](#)

washers, using [53](#)



- weight specifications [165](#)
- wheel chocks [177](#)
- wheels
 - alignment [136](#)
 - replacing [137](#)
 - specifications [169](#)
- Wi-Fi, connecting to [124](#)
- windshield washer fluid, topping up [151](#)
- winter tires [138](#)
- wiper blades, replacing [147](#)
- wipers and washers [53](#)
- wipers, de-icing [53](#)

X

- XM radio [110](#)